



CAMERE / BEDROOMS

FACILE 2.0



MADE IN ITALY



## CATALOGO CATALOGUE

Facile 2.0	<b>2</b>
Nuovi gruppi New sets	<b>8</b>
Camere Bedrooms	<b>10</b>
Camere a ponte Bridge bedrooms	<b>44</b>

## DATI TECNICI TECHNICAL

Finiture Finishes	<b>54</b>
Caratteristiche tecniche armadi battenti Hinged doors wardrobes technical features	<b>56</b>
Caratteristiche tecniche armadi scorrevoli Sliding doors wardrobes technical features	<b>64</b>
Caratteristiche tecniche gruppi Bedroom sets technical features	<b>70</b>
Caratteristiche tecniche letti Beds technical features	<b>78</b>

## PRICE LIST

Listino Price list	<b>86</b>
Composizioni a catalogo Catalogue compositions	<b>124</b>

# FACILE 2.0

Comporre nuovi spazi, non è mai stato così Facile!

Questo progetto è pensato e realizzato per creare ambienti personalizzati e su misura per te.

Ridisegniamo la zona notte, facilitando le tue abitudini e dando forma ai tuoi desideri.

Una vasta gamma di proposte che combinano moduli, finiture ed elementi, puntando su estetica, funzionalità e ottimo rapporto qualità prezzo.

With Facile, creating new spaces has never been so easy!

This project is conceived and produced to create rooms tailored to your personality and needs.

We redesign your bedroom to respond to your habits and let your wishes take shape.

A vast range that combines modules, finishes and elements, offering style, convenience and excellent value for money.



## Finiture

Cinque nuove finiture si aggiungono per arricchire la gamma di nuance del programma: Noce biondo, Metallo oro, Metallo argento, Bianco altea, Bianco.

## Finishes

Five new finishes are added to expand the programme's colour assortment: Noce biondo, Metallo oro, Metallo argento, Bianco altea, Bianco.



## Maniglia

M2: Geometria e versatilità, sono le caratteristiche della nuova maniglia che unisce estetica e funzionalità.

## M2 Handle

Geometrical and versatile, the new handle is both attractive and functional.

## Pomolo

Il pomolo, dona una maggiore ergonomia ed eleganza alle ante in vetro.

## Knob

The knob enhances both the elegance and the convenience of glass doors.



**Thai**

Composto di comò, comodino e settimino, il gruppo è disponibile con maniglia dedicata, vano a giorno e piano a vista.

**Thai**

Comprising chest of drawers, bedside table and tallboy, the set is available with special handle, open section and shelf.



**Duo**

Nuove finiture e maniglie, per arredare la tua zona notte ottimizzando i volumi di contenimento.

**Duo**

New finishes and handles to furnish your bedroom with style and optimise storage spaces.



**Nuovo ponte con moduli laterali da 90**

Dal design lineare, elementi discreti e pratici per mantenere tutto in ordine. Pensato in linea allo stile semplice della collezione.

**New overhead composition with 90 cm side modules.**

Simply styled, with tasteful, practical elements to keep everything neat and tidy. Designed to blend into the collection's unfussy style.



#### **Elemento scrivania**

Eleganza e funzionalità: un elemento versatile, per goderti tutto il comfort su misura per te.

#### **Desk element**

Elegant and functional: a versatile element, so you can enjoy comfort tailored to your preferences.



#### **Portavaligia**

Una soluzione per le tue esigenze, e per sfruttare al meglio lo spazio. Nella camera ideale, i tuoi progetti vengono al primo posto.

#### **Luggage stand**

A solution for your needs, to make optimal use of space. In the ideal bedroom, your ideas come first.



#### **Nuovi letti**

Letti moderni arredano la zona notte e ci accolgono in un morbido abbraccio nei momenti di relax. Nelle proposte imbottite il rivestimento garantisce una comodità senza eguali, in un'atmosfera chic ed ovattata. Pratiche ed essenziali, le proposte con struttura in legno, introducono un nuovo concetto di modernità ed essenzialità molto contemporaneo.

#### **New beds**

New, modern beds add style to the bedroom and envelop us in a soft embrace when it's time to relax. In the padded bedheads, the upholstery provides unrivalled comfort - chic and soft. Practical and elegant, the wooden frame beds offer a new, very contemporary concept of modernity and simplicity.



# Nuovi gruppi / New sets



Il programma Facile presenta due new entries nella proposta notte: nuove finiture, nuovo design e nuove maniglie. Thai e Duo rappresentano un'importante innovazione, arricchiscono la gamma di prodotti, introducendo un nuovo concetto di modernità.

The Facile programme offers two bedroom new entries: new finishes, new design and new handles. Thai and Duo are strongly innovative, enhancing the product range and introducing a new concept of modernity.

Duo



Thai



Cady



Lux



Small



Aux

Con una gamma di finiture nuova ed arricchita e la proposta di nuove maniglie, i gruppi del programma Facile si vestono di nuovo. All'interno delle proposte troverete il gruppo Cady, Small, Lux e Aux, abbinati agli armadi e i letti della proposta notte, studiati per aiutarvi a realizzare il vostro personalissimo progetto di casa.

With a new, wider range of finishes and new handles, the Facile programme sets acquire a new look. The offering includes the Cady, Small, Lux and Aux set, styled to match the wardrobes and beds in the bedroom assortment, designed to enable you to create your very own home furnishing project.



CAMERE  
BEDROOMS



VFB005

**Gruppo Aux / Aux Set:** Bianco

**Armadio / Wardrobe:** Olmo natura / Bianco

**Letto Reflex / Reflex bed:** Olmo natura





**VFB003**

**Gruppo Cady / Cady Set:** Noce biondo / Metallo oro

**Armadio / Wardrobe:** Noce biondo / Metallo oro

**Letto Era / Era bed:** Tessuto nabuk cetra beige

VFB002

**Gruppo Small / Small Set:** Bianco altea / Metallo argento

**Armadio / Wardrobe:** Bianco altea

**Letto Slim / Slim bed:** Bianco altea / Metallo argento





VFB016

**Gruppo Thai / Thai Set:** Bianco altea / Metallo argento

**Armadio / Wardrobe:** Bianco altea / Metallo argento

**Letto Reflex / Reflex bed:** Bianco altea

VFB015

**Gruppo Thai / Thai Set:** Olmo natura / Metallo oro

**Armadio / Wardrobe:** Olmo natura / Metallo oro

**Letto Misam / Misam bed:** Ecopelle lira tortora



VFB014

**Gruppo Lux / Lux Set:** Orzo

**Armadio / Wardrobe:** Orzo

**Letto Dione / Dione bed:** Tessuto nabuk cetra antracite





VFB013

**Gruppo Cady / Cady Set:** Noce biondo / Bianco lucido

**Armadio / Wardrobe:** Noce biondo / Bianco lucido

**Letto Atik / Atik bed:** Ecopelle lira bianco



**VFB009**

**Gruppo Duo / Duo Set:** Bianco altea / Metallo argento

**Armadio / Wardrobe:** Bianco altea / Metallo argento

**Letto Vulcano / Vulcano bed:** Bianco altea



VFB012

**Gruppo Duo / Duo Set:** Noce biondo / Metallo oro

**Armadio / Wardrobe:** Noce biondo / Metallo oro

**Letto Slim / Slim bed:** Noce biondo / Metallo oro





VFB011

**Gruppo Aux / Aux Set:** Bianco altea  
**Armadio / Wardrobe:** Bianco altea / Bianco lucido  
**Letto Vulcano / Vulcano bed:** Bianco altea

VFB001

**Gruppo Aux / Aux Set:** Orzo

**Armadio / Wardrobe:** Noce biondo

**Letto Metiz / Metiz bed:** Noce biondo / Orzo





**VFB006**

**Gruppo Duo / Duo Set:** Noce biondo / Metallo argento

**Armadio / Wardrobe:** Noce biondo / Metallo argento

**Letto Reflex / Reflex bed:** Noce biondo



VFB010

Gruppo Small / Small Set: Bianco altea  
Armadio / Wardrobe: Bianco altea  
Letto Metiz / Metiz bed: Bianco altea

VFB004

**Gruppo Small / Small Set:** Olmo natura

**Armadio / Wardrobe:** Olmo natura

**Letto Metiz / Metiz bed:** Olmo natura



VFB007

**Gruppo Thai / Thai Set:** Noce biondo / Orzo

**Armadio / Wardrobe:** Noce biondo

**Letto Metz / Metz bed:** Noce biondo / Orzo

**Scrivania frigo / Scrivania frigo:** Noce biondo

**Portavaligie / Portavaligie:** Noce biondo



VFB008

**Gruppo Small / Small Set:** Olmo natura / Metallo argento

**Armadio / Wardrobe:** Olmo Natura / Metallo Argento

**Letto Resort / Resort bed:** Olmo natura / Metallo argento

**Scrivania frigo / Scrivania frigo:** Olmo natura / Metallo argento

**Portavaligie / Portavaligie:** Olmo natura







CAMERE A PONTE  
BRIDGE BEDROOMS

VFB017

**Armadio a ponte / Bridge wardrobe:** Bianco altea/ Bianco lucido/ Metallo argento

**Letto Reflex / Reflex bed:** Bianco altea

**Comò Aux / Comò Aux:** Bianco lucido



VFB018

**Armadio / Wardrobe:** Olmo natura / Metallo oro

**Armadio a ponte / Bridge wardrobe:** Olmo natura / Metallo oro

**Letto Vulcano / Vulcano bed:** Olmo natura



VFB019

**Armadio / Wardrobe:** Noce biondo / Metallo argento

**Armadio a ponte / Bridge wardrobe:** Noce biondo / Metallo argento

**Letto Vulcano / Vulcano bed:** Noce biondo



TECHNICALS

# FINITURE FINISHES

## (NO) NOBILITATI / MELAMINE FINISHES

### ESSENZE / WOOD FINISHES

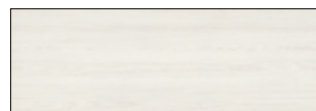

Bianco altea



Olmo natura



Noce biondo

### COLORATI / COLOURED FINISHES



Bianco nobilitato

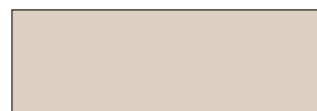

Orzo

### EFFETTO METALLO / METAL EFFECT

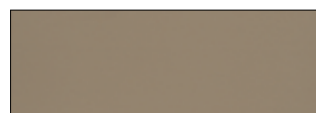

Oro

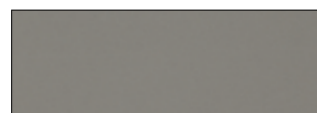

Argento

## (LC) LACCATI / LACQUERED FINISHES

### LACCATI LUCIDI / GLOSSY LACQUERED FINISHES



Bianco lucido

## (CA) ECOPELLE CALI / CALI ECOLEATHER



Bianco



Fango

## (LR) ECOPELLE LIRA / LIRA ECOLEATHER



Bianco  
\*Rif. Ecopelle Cali Bianco (H0)



Tortora  
\*Rif. Pelle Royal Marrone (O3)

\* I tessuti di riferimento non hanno valore contrattuale e sono puramente indicativi. Rispettano la cromia ma non la trama. The reference fabrics haven't contract value and are purely indicative. They respect the colors but not the texture.

## (CT) NABUK CETRA / CETRA NABUK

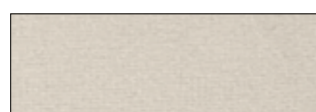

Beige  
\*Rif. Tessuto Apollo Beige (P0)

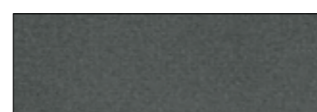

Antracite  
\*Rif. Tessuto Apollo Antracite (P6)

\* I tessuti di riferimento non hanno valore contrattuale e sono puramente indicativi. Rispettano la cromia ma non la trama. The reference fabrics haven't contract value and are purely indicative. They respect the colors but not the texture.

## FINITURA INTERNA / INTERNAL FINISH



Tessuto glamour

## TIPOLOGIE DI SPECCHIO / MIRROR TYPES

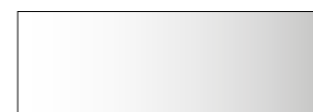

Specchio neutro

Alcuni elementi possono avere una diversa finitura interna a seconda della finitura esterna. Consultare la tabella sottostante per le varie combinazioni. Some units may have different internal finish according to its external finish. Check the combinations in the table below.

	Esterno in Essenza o Nobilitati Colorati	Esterno Laccato	Esterno Specchio
Ante Doors	Interno stesso colore Same colour	Interno Bianco nobilitato Internal side in Bianco nobilitato	Interno Tessuto Glamour Internal side in Tessuto Glamour
Fianchi Sides	Interno stesso colore Same colour	Interno Bianco nobilitato Internal side in Bianco nobilitato	-
Base, Cappello e Ripiani / Base, Top and Shelves	Sempre in Tessuto Glamour / Always Tessuto Glamour		
Tramezzi Internal sides	Sempre in Tessuto Glamour / Always Tessuto Glamour		
Schiene Back panels	Sempre in Tessuto Glamour / Always Tessuto Glamour		

## CARATTERISTICHE TECNICHE ARMADI BATTENTI

### HINGED DOORS WARDROBES TECHNICAL FEATURES

#### MATERIALI E PANNELLI / MATERIALS AND PANELS

Per informazioni su materiali e pannelli, consultare la scheda prodotto in fondo al listino.  
For information about materials and panels, check the product sheet in the last pages of this document.

#### FIANCHI E TRAMEZZI / SIDES

Tutti i fianchi e tramezzi sono realizzati in pannelli di particelle di legno classe E1 di spessore 18mm e sono predisposti di forature per fissaggio ferramenta (fori 1x1). I fianchi in finitura nobilitato colorato ed essenza sono dello stesso colore anche nel lato interno. I fianchi laccati sono laccati nel lato esterno e nobilitati dello stesso colore nel lato interno.

Each side or internal side is realized with E1 class wooden panels, thickness 18mm. Sides in melamine and wood finishes have the same finish in the inner side. The lacquered sides have melamine finish (same colour but not lacquered) in the inner side.

#### ANTE / DOORS

Tutte le ante sono realizzate in pannelli di particelle di legno classe E1 di spessore 18mm. Se l'anta è in finitura laccata, l'interno sarà in nobilitato dello stesso colore del frontale. Se è in essenza, anche il lato interno è in finitura essenza. L'interno dell'anta a specchio è in finitura Tessuto. Il bordo anta è sempre opaco, anche con finitura lucida. Le ante sono preforate internamente per il montaggio di tutti i modelli di maniglia.

Each door is realized with E1 class wooden panels, thickness 18mm. If the door is made in a lacquered colour, the internal side will be in melamine finish of the same colour of the frontal. If the door is in essence finish, the internal side will be in essence finish too. The internal side of the mirror doors are in Tessuto. Even with glossy finish, the edges are always in matt finish.

#### DOTAZIONE INTERNA STANDARD / STANDARD EQUIPMENT

Tutti gli armadi vengono forniti con ripiani interni spessore 25mm e tubi appendiabiti a sezione ovale in alluminio. Finitura interna: Tessuto Glamour.  
Each wardrobe is provided with 25mm thick shelves and oval hanger tubes. Internal finish: Tessuto Glamour.

##### Moduli lineari

1 ripiano e 2 tubi  
Linear units  
1 shelf and 2 tubes

##### Elementi ponte

1 tubo per vano  
Bridge units  
1 tube for each unit

##### Terminali

5 ripiani (H.245)  
4 ripiani (H.225)  
End units  
5 shelves (H.245)  
4 shelves (H.225)

##### Angoli

1 ripiano e 2 tubi  
Corner units  
1 shelf and 2 tubes

##### Cabine

1 ripiano e 2 tubi  
Clothes closet units  
1 shelf and 2 tubes

#### INFORMAZIONI TECNICHE / TECHNICAL INFORMATION

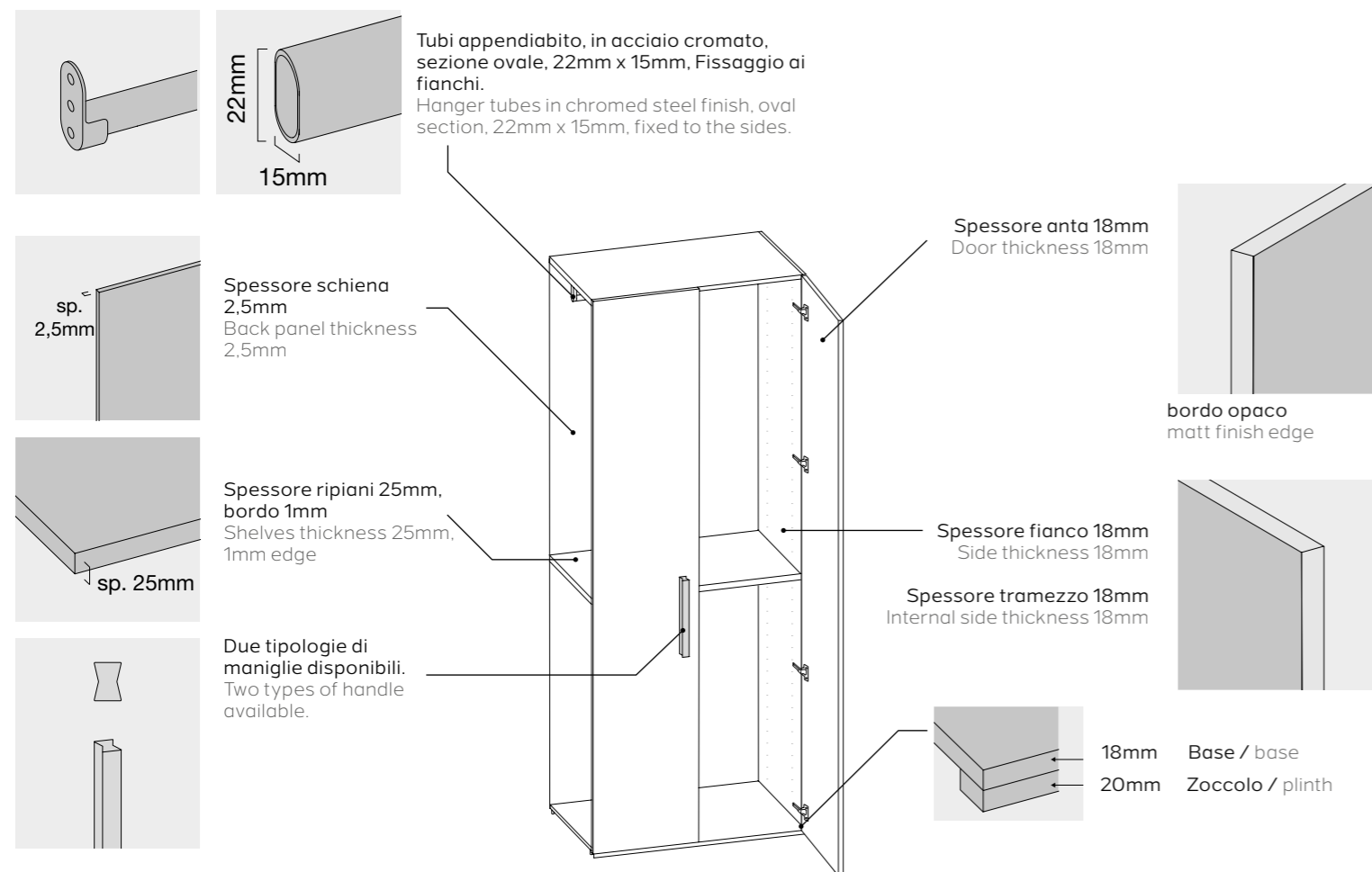

#### SPAZIO PER MONTAGGIO IN NICCHIA / MINIMUM GAP FROM CEILING

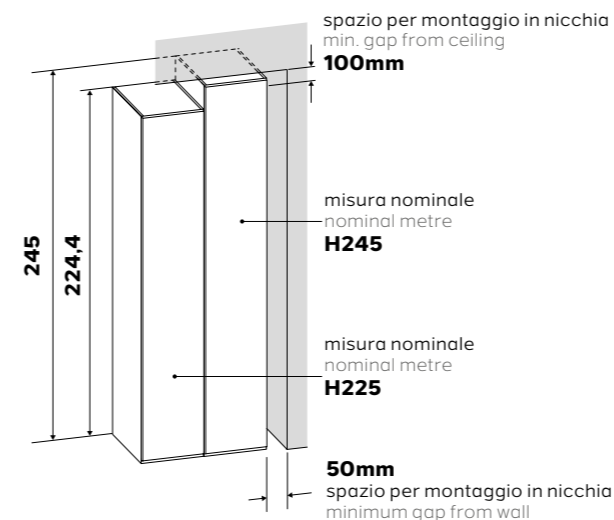

#### FORATURA FIANCHI E POSIZIONAMENTO / SIDES' HOLES AND POSITIONING

Nei moduli con anta H.245 e H.225 è possibile posizionare il ripiano ogni 6,4cm, ma è consigliabile assemblare il vano con posizione ripiano di serie come indicato nelle figure **A** e **B** (verificare dotazione interna).

You can put the shelves every 6.4cm but it's recommended to put them as shown in the pictures **A** and **B**.

##### H245

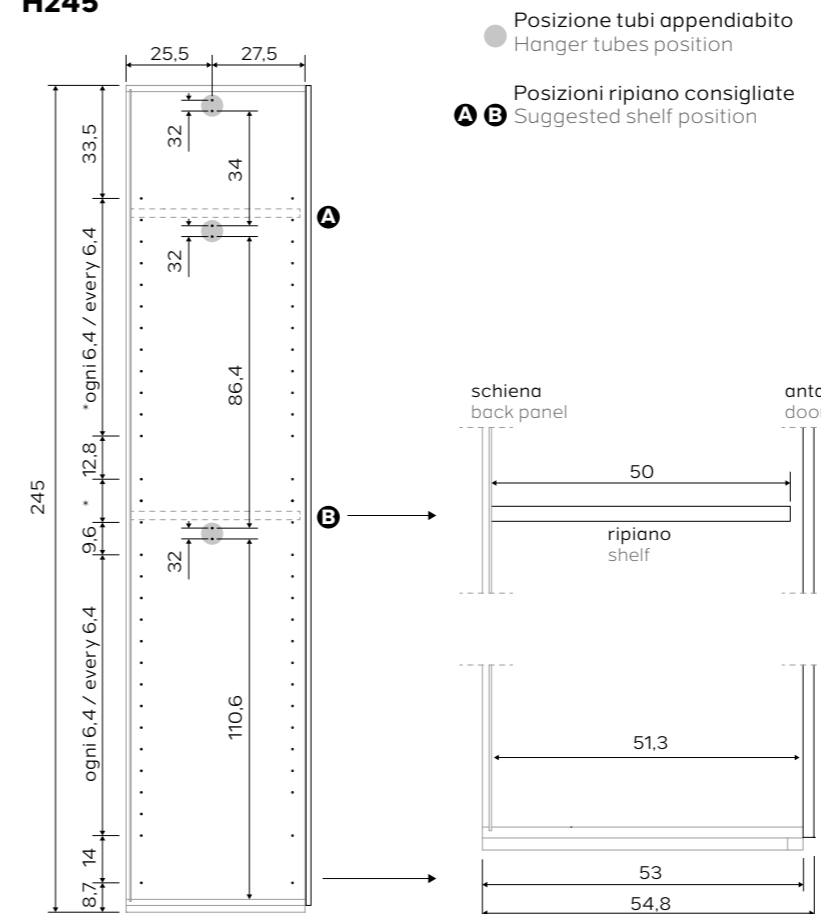

##### H225

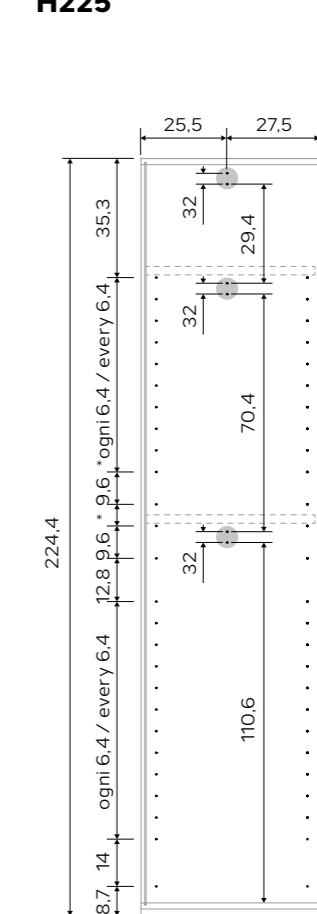

# INGOMBRI MODULI

## UNITS MEASURES

### ARMADI LINEARI / LINEAR WARDROBES

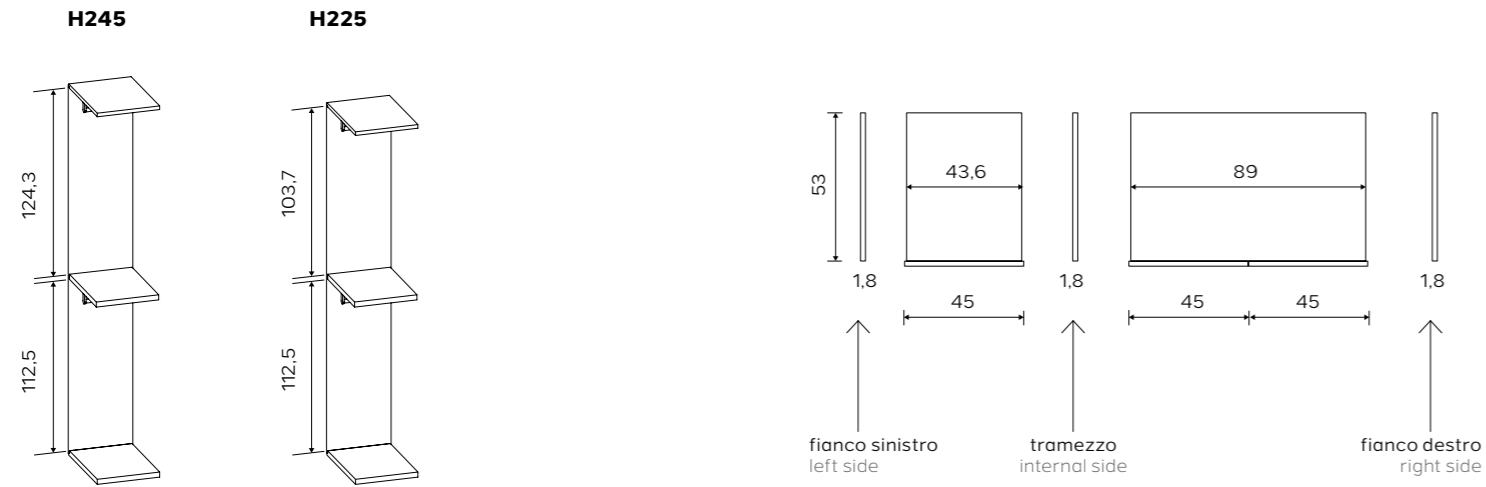

### CABINA / CLOTHES CLOSET UNIT

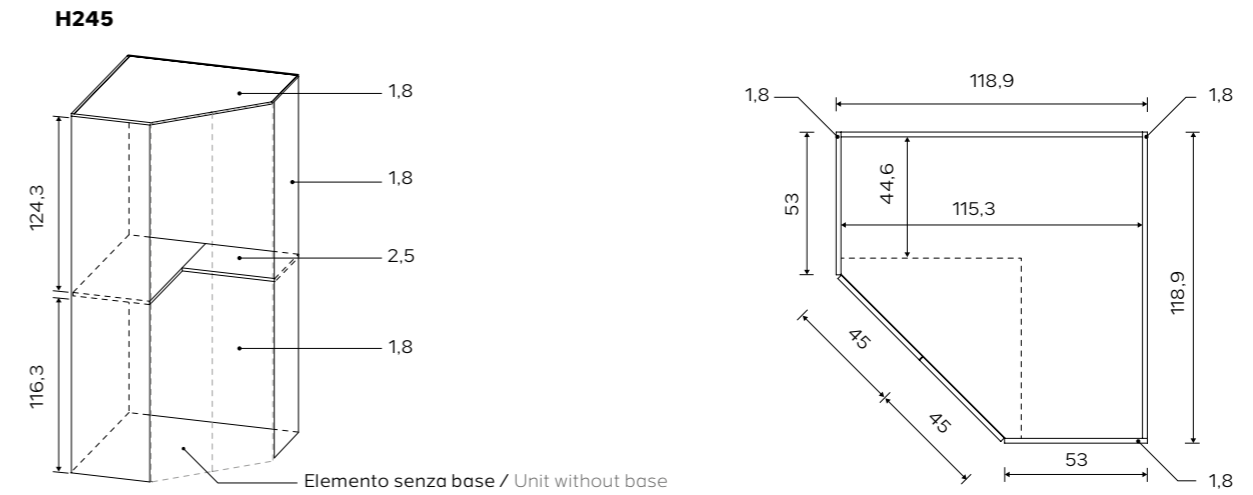

### TERMINALE / END UNIT

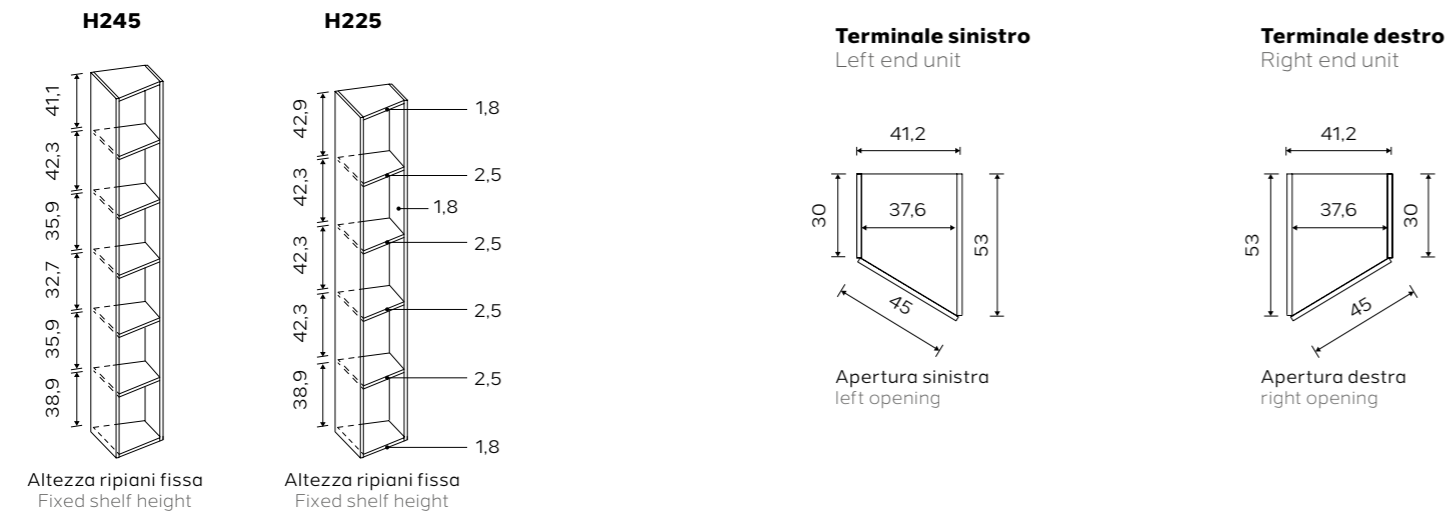

### LIBRERIA L35 / L35 BOOKCASE UNIT

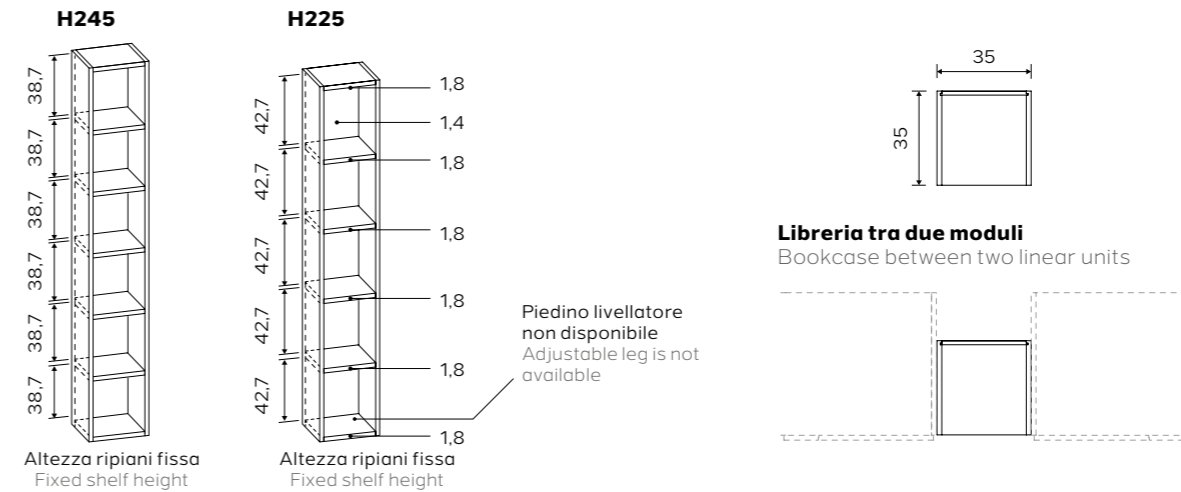

### ANGOLO / CORNER UNIT

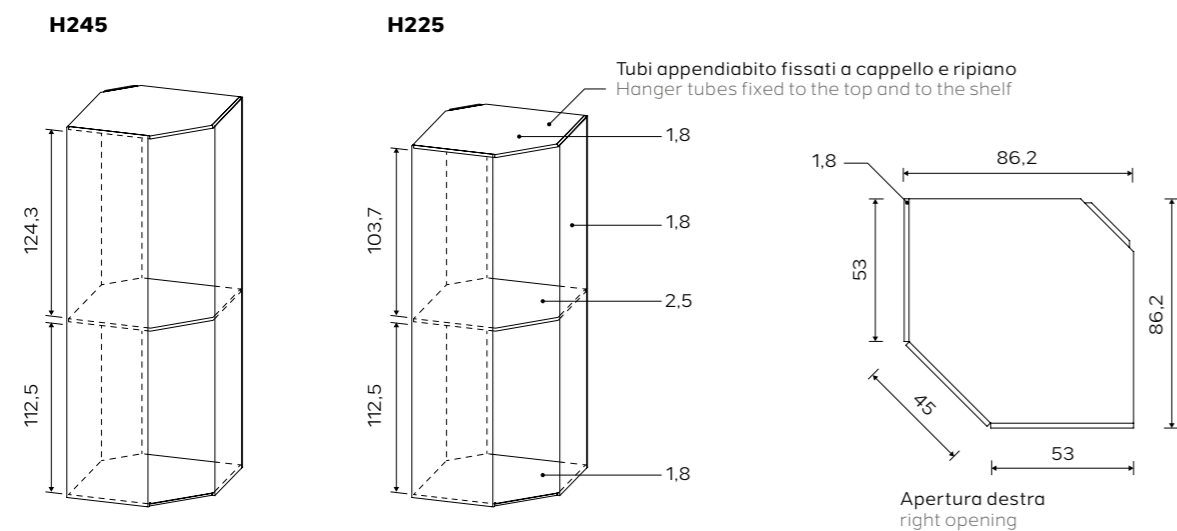

### PONTE / BRIDGE UNIT

Ante ponte senza maniglia / Bridge unit's doors without handles

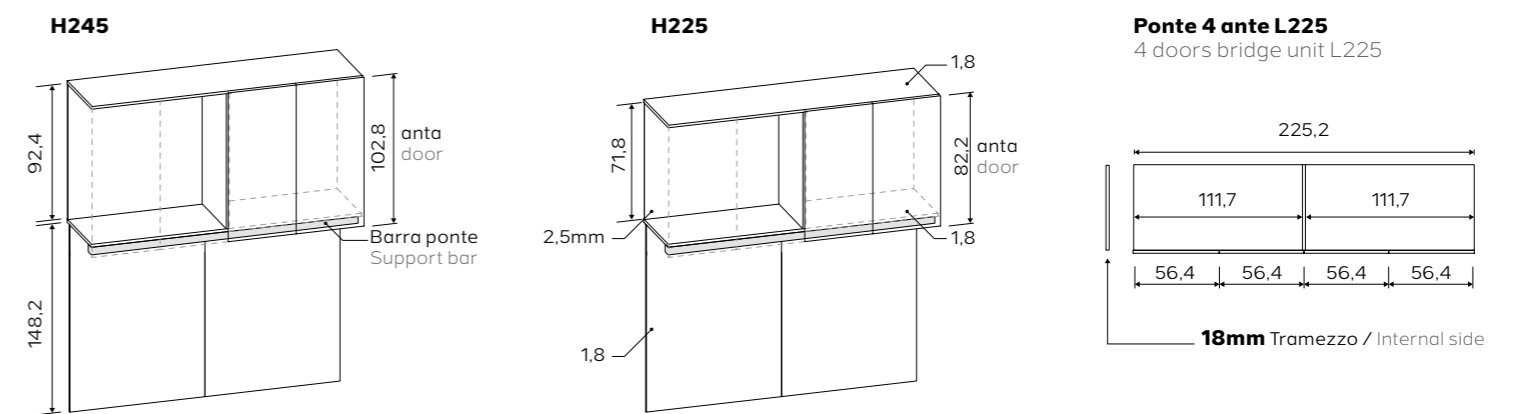



## ACCESSORI PONTE BRIDGE UNIT ACCESSORIES

### LIBRERIE PONTE / BOOKCASES FOR BRIDGE UNIT

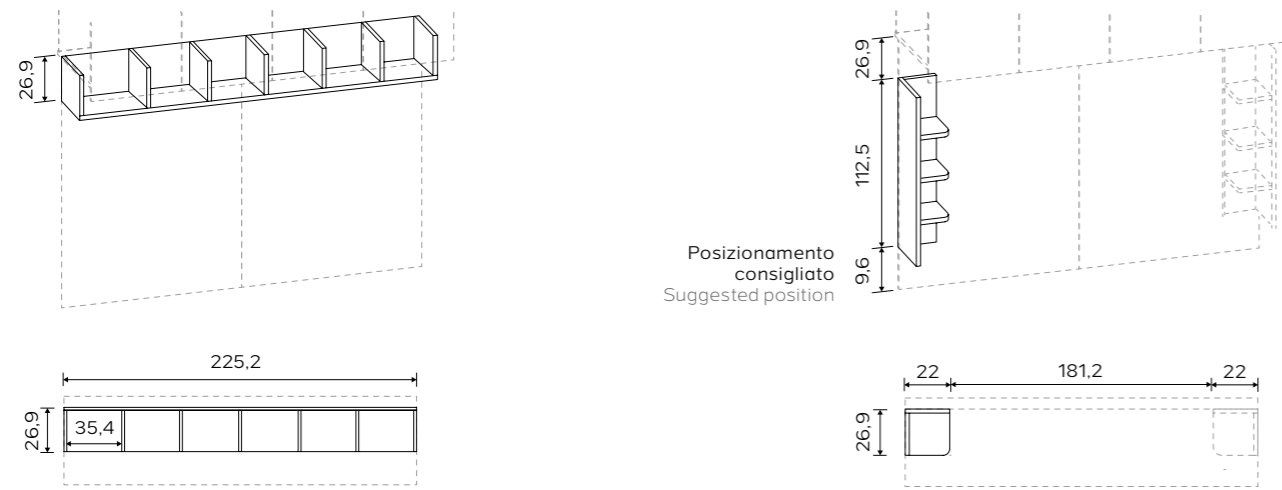

### MENSOLA SOTTOPONTE / SHELF FOR BRIDGE UNIT



## BOISERIE CON PORTAVALIGIA E SPECCHIO APPLICATO BOISERIE WITH LUGGAGE RACK AND MIRROR

### BOISERIE CON PORTAVALIGIA E SPECCHIO APPLICATO / BOISERIE WITH LUGGAGE RACK AND MIRROR

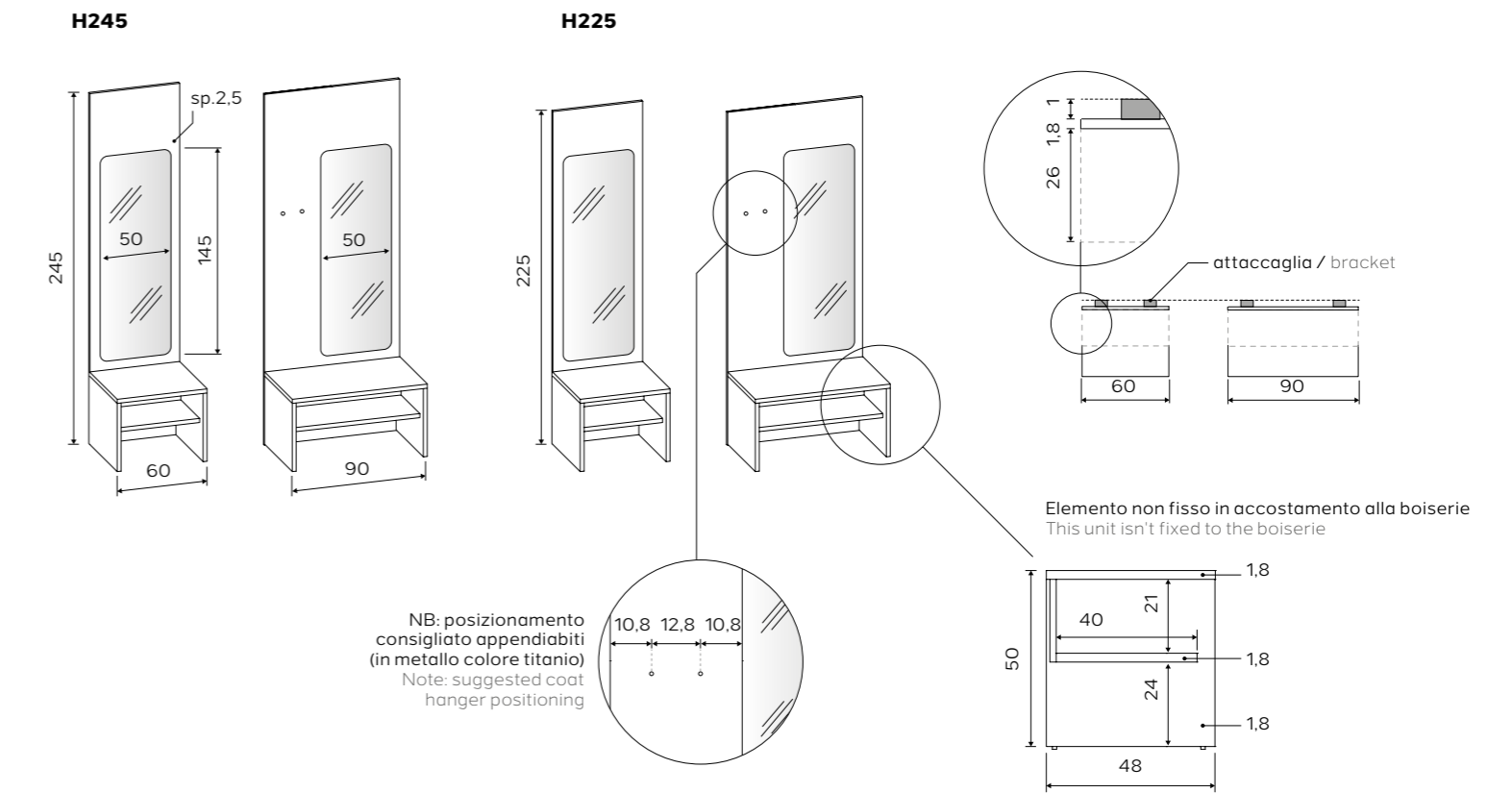

### MONTAGGIO / ASSEMBLY

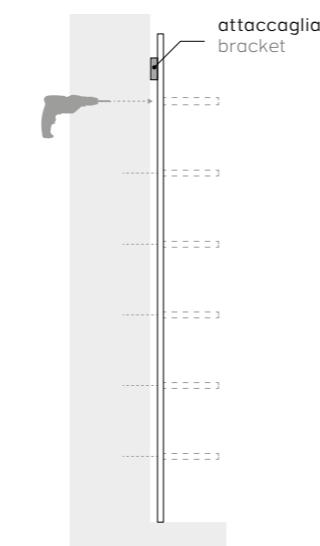

I pannelli boiserie sono dotati di fori sul lato posteriore per fissaggio attaccaglie e mensole da forare per inserimento reggimensola interno. La posizione delle mensole è fissa (vedi disegni tecnici nella pagina precedente).

There are prearranged holes on the back side of the boiserie. The holes must be pierced to apply the brackets and the internal supports. The position of the shelves is fixed (check the schemes in the previous page)

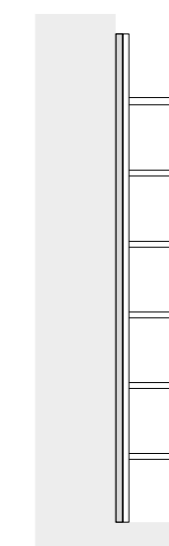

Il pannello boiserie è rifinito con un profilo biadesivo da applicare sul retro per coprire le attaccaglie di fissaggio.

The boiserie is equipped with a double-sided tape that must be applied in the back side to cover the brackets.

# MANIGLIE PER ARMADI

## HANDLES FOR WARDROBES

### MANIGLIA M1 / HANDLE M1

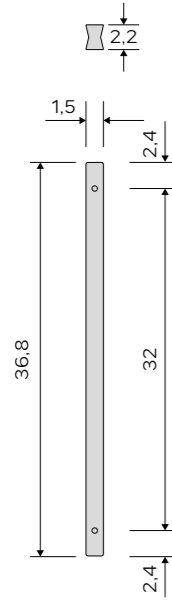

Maniglia L37 in MDF rivestito.  
Finiture essenza o bianco lucido.  
Passo 320mm

L37 MDF covered handle.  
Wooden finishes and bianco lucido.  
Hole pitch 320mm

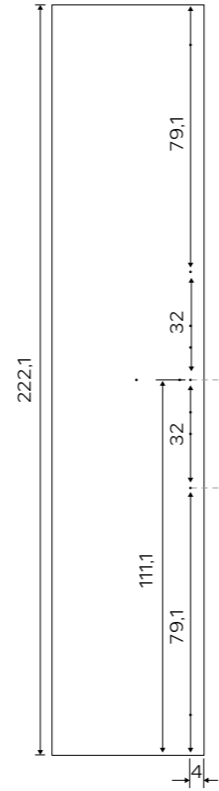
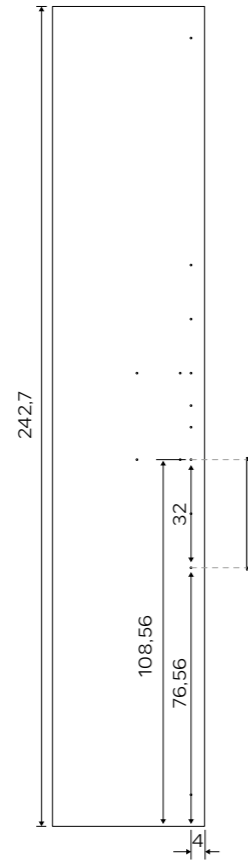

### POMOLO PER ANTA SPECCHIO / KNOB FOR MIRROR DOOR

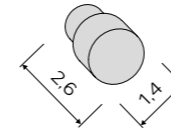

Pomolo in acciaio finitura titanio.  
Passo: foro singolo.

Steel knob in titanium colour.  
Hole pitch: single hole.

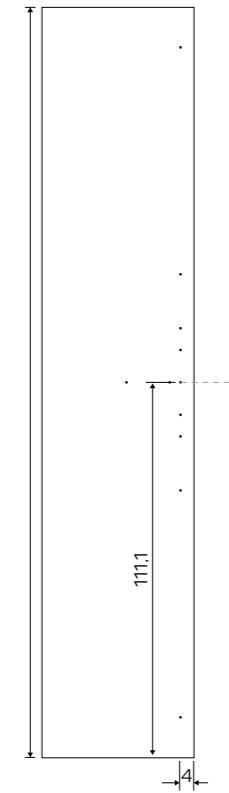
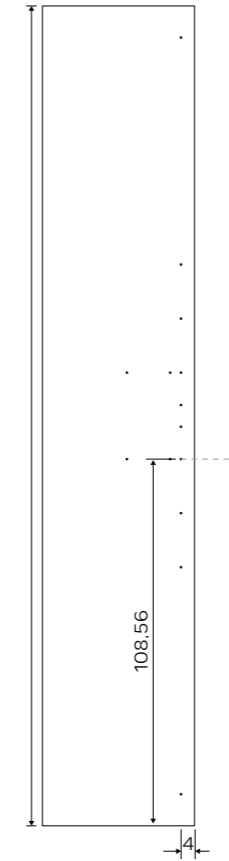

### MANIGLIA M2 / HANDLE M2

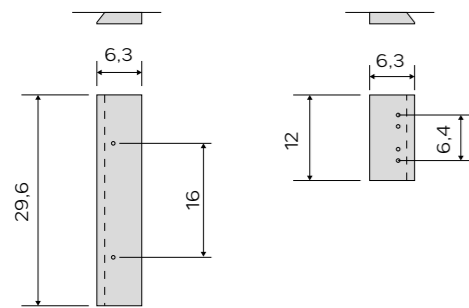

Maniglia L12 e L30 in MDF rivestito.  
Finiture essenza o bianco lucido.  
Passo: 160mm (maniglia lunga)  
64mm (maniglia corta)  
NB: su anta singola, solo maniglia L30

L12 and L30 MDF covered handle.  
Wooden finishes and bianco lucido.  
Hole pitch: 160mm (long handle)  
64mm (short handle)  
Note: single door wardrobe equipped with a single L30 handle.

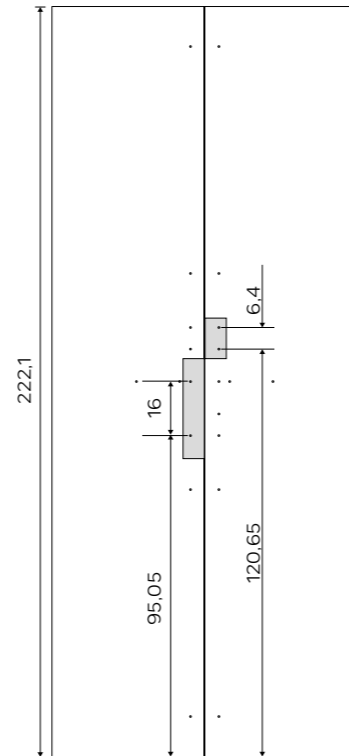
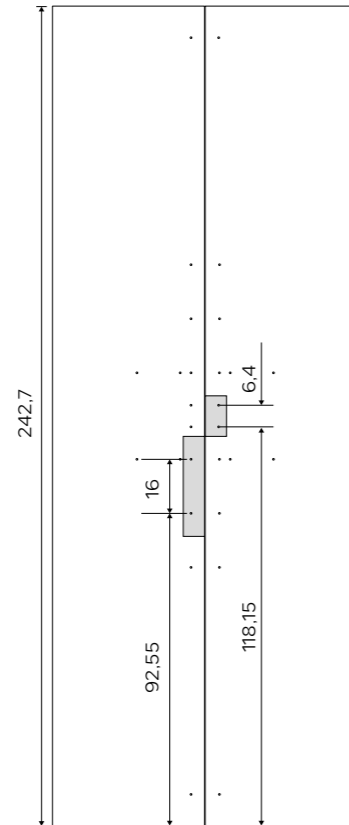

## CARATTERISTICHE TECNICHE ARMADI SCORREVOLI

### SLIDING DOORS WARDROBES TECHNICAL FEATURES

#### MATERIALI E PANNELLI / MATERIALS AND PANELS

Per informazioni su materiali e pannelli, consultare la scheda prodotto in fondo al listino.  
For information about materials and panels, check the product sheet in the last pages of this document.

#### FIANCHI E TRAMEZZI / SIDES

Fianchi e tramezzi: tutti i fianchi e tramezzi sono realizzati in pannelli di particelle di legno classe E1. Fianchi sp.25mm, tramezzi sp.18mm, tramezzo speciale per armadio scorrevole 4 ante sp.25mm. Sono predisposti di forature per fissaggio ferramenta (fori 1x1). I fianchi in finitura nobilitato colorato ed essenza sono dello stesso colore anche nel lato interno. I fianchi laccati sono laccati nel lato esterno e nobilitati dello stesso colore nel lato interno.

Each side or internal side is realized with E1 class wooden panels. Thickness: 25mm sides, 18mm internal sides, 25mm special internal side for 4 sliding doors wardrobe. Sides in melamine and wood finishes have the same finish in the inner side. The lacquered sides have melamine finish (same colour but not lacquered) in the inner side.

#### ANTE / DOORS

Le ante sono realizzate in pannelli di particelle di legno classe E1 di spessore 18mm.

Se l'anta è in finitura laccata lucida, l'interno sarà in nobilitato dello stesso colore del frontale. Se è in essenza, anche il lato interno è in finitura essenza. L'interno dell'anta a specchio è in finitura Tessuto.

The doors are realized with E1 class wooden panels, thickness 18mm. If the door is made in a lacquered colour, the internal side will be in melamine finish of the same colour of the frontal. If the door is in essence finish, the internal side will be in essence finish too.

The internal side of the mirror doors are in Tessuto.

#### DOTAZIONE INTERNA STANDARD / STANDARD EQUIPMENT

Dotazione interna: tutti gli armadi vengono forniti con ripiani interni e fianchi spessore 25mm e tubi appendiabiti a sezione ovale in alluminio. Ogni vano è dotato di un ripiano centrale e 2 tubi appendiabiti.

Standard equipment: each wardrobe is provided with 25mm thick shelves and oval hanger tubes. Internal finish: Tessuto Glamour.

Each wardrobe is provided with 25mm thick central shelf and 2 oval hanger tubes. Internal finish: Tessuto Glamour.

#### INFORMAZIONI TECNICHE / TECHNICAL INFORMATION

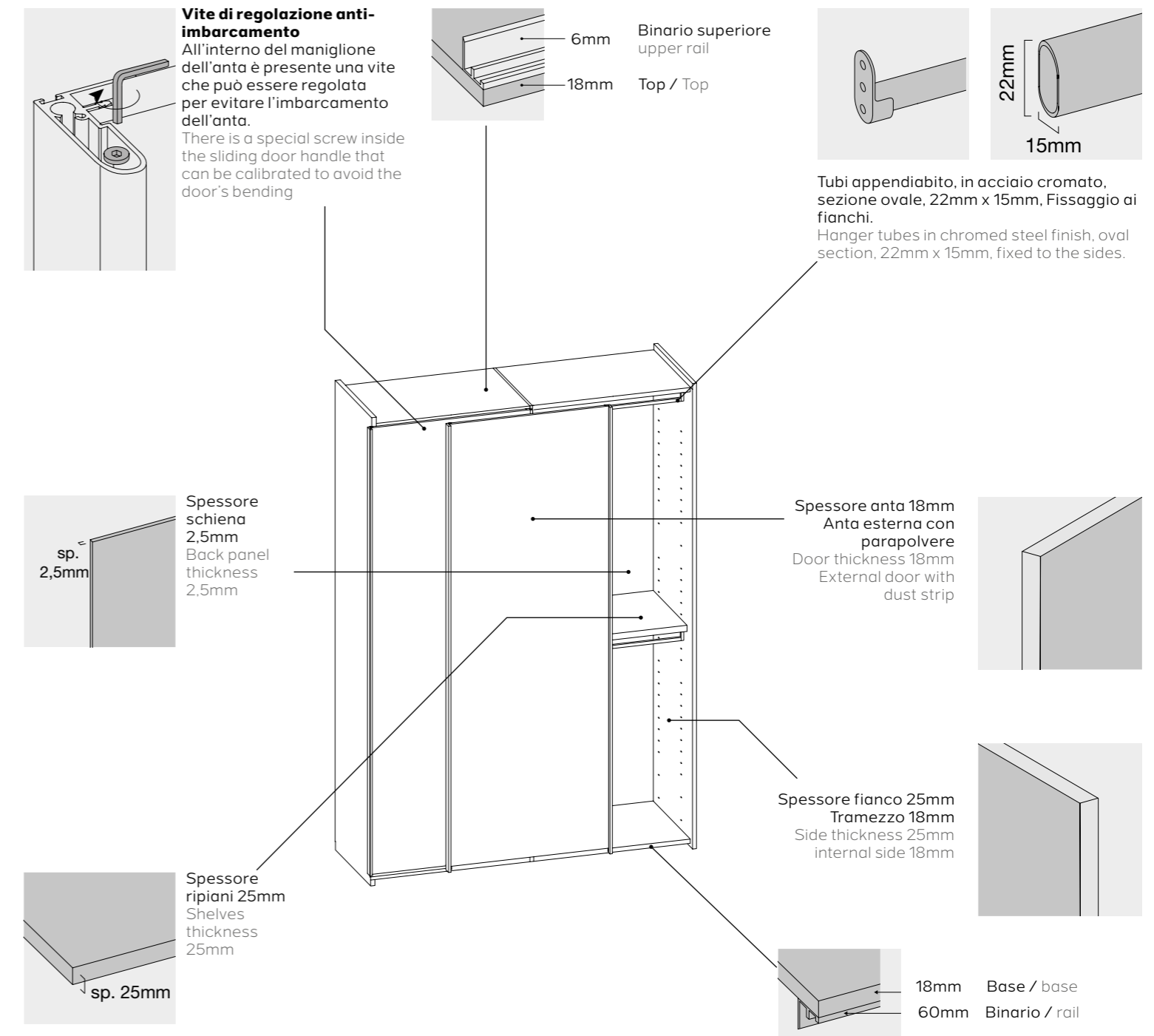

# CARATTERISTICHE TECNICHE ARMADI SCORREVOLI

## SLIDING DOORS WARDROBES TECHNICAL FEATURES

### ALTEZZE / HEIGHTS

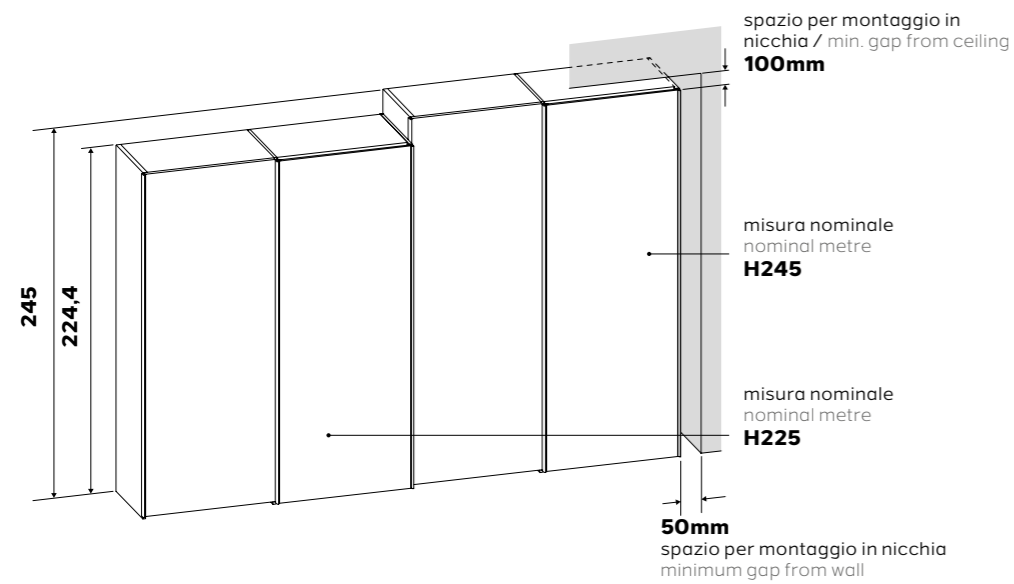

### PROFONDITÀ / DEPTHS

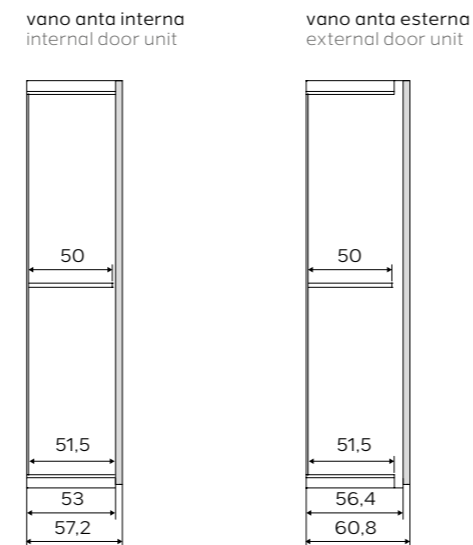

### INGOMBRI INTERNI / INTERNAL MEASURES

H245

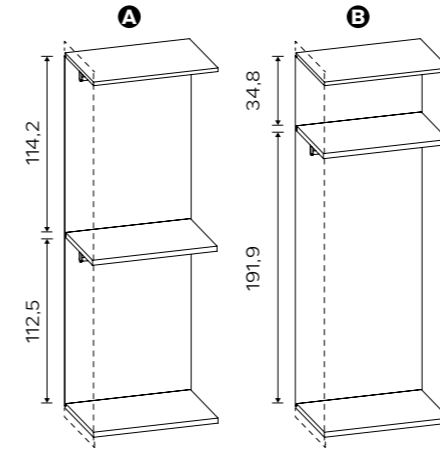

H225

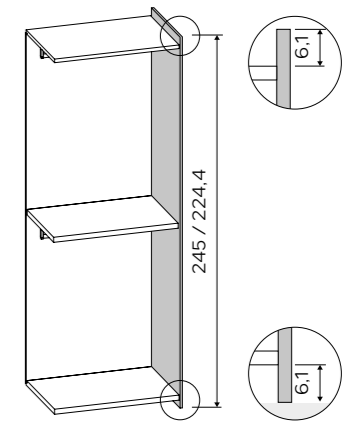
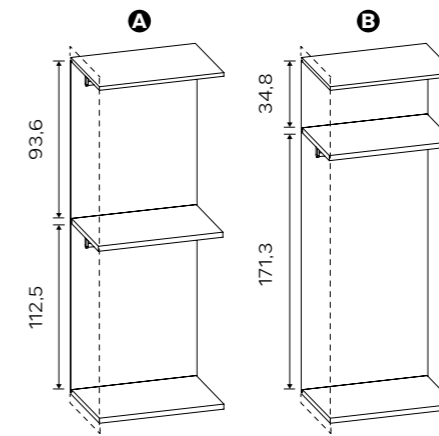

### LARGHEZZE ARMADI L90

#### L90 UNITS WIDTHS

**2 Ante L90**  
2 L90 Doors

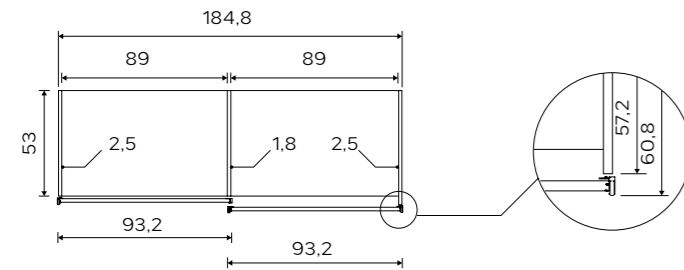

### LARGHEZZE ARMADI L120-135

#### L120-135 UNITS WIDTHS

**2 Ante L120**  
2 L120 Doors

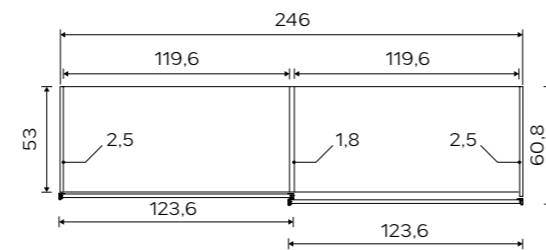

**2 Ante L135**  
2 L135 Doors

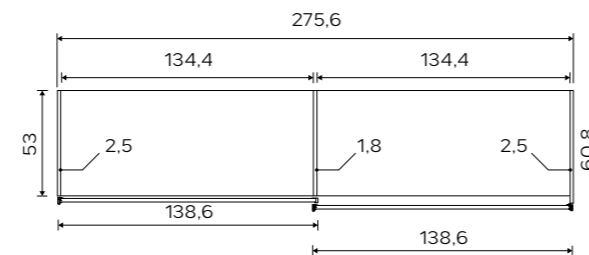

**3 Ante L90**  
3 L90 Doors

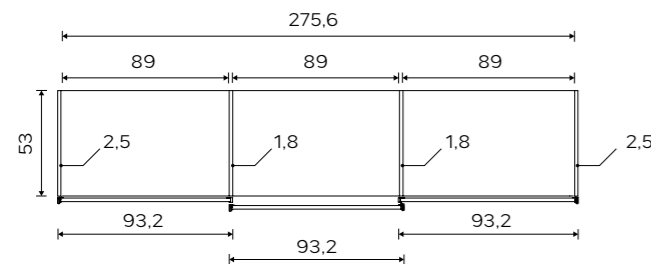

**4 Ante L90**  
4 L90 Doors

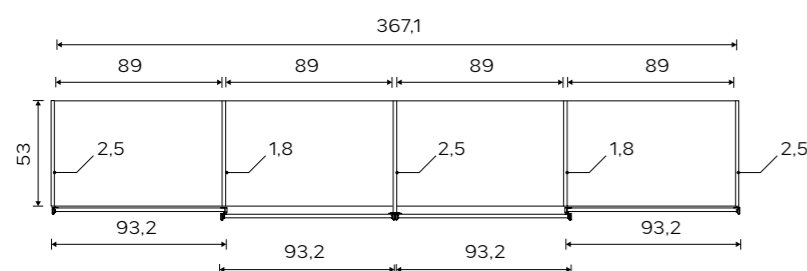

Nei moduli con anta H.245 e H.225 è possibile posizionare il ripiano ogni 6,4cm, ma è consigliabile assemblare il vano con posizione ripiano di serie come indicato nelle figure A e B (verificare dotazione interna).  
You can put the shelves every 6.4cm but it's recommended to put them as shown in the pictures A and B.

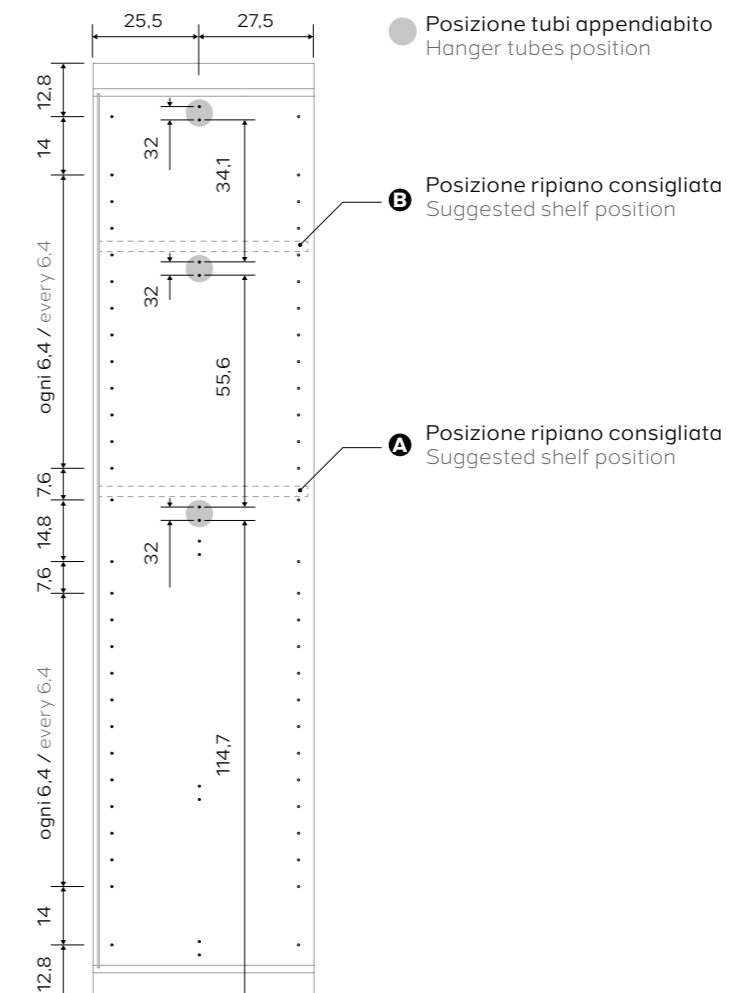
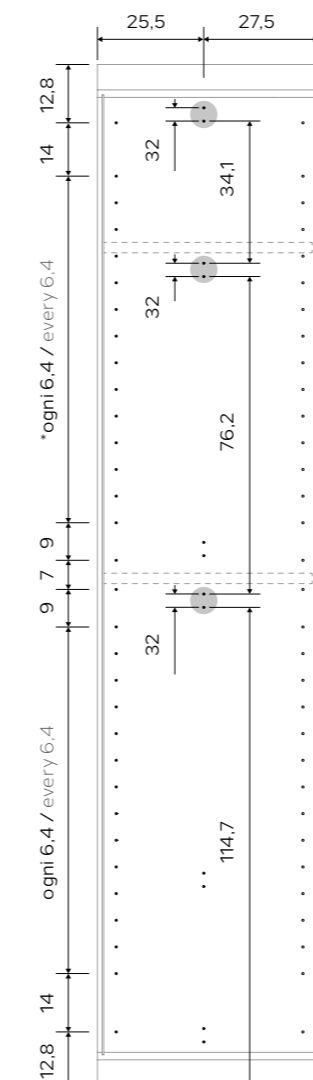

## FIANCHI E MANIGLIONI SIDES AND HANDLES

### MANIGLIONI ANTA INTERNA INTERNAL DOOR'S HANDLE

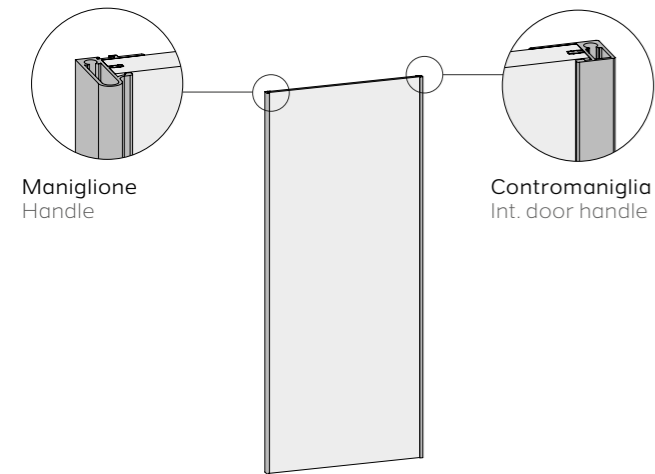

### MANIGLIONI ANTA ESTERNA EXTERNAL DOOR'S HANDLE

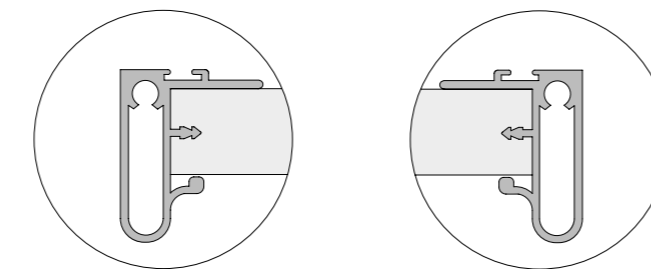
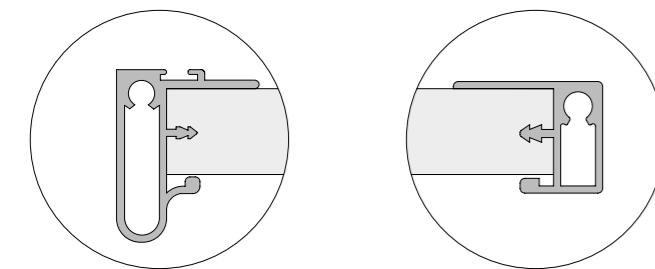
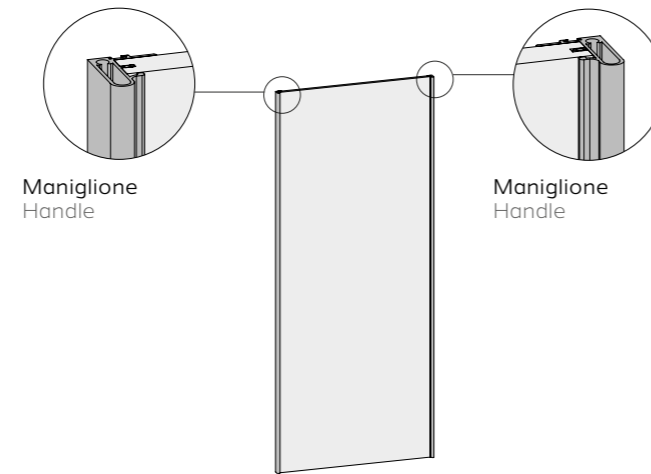

#### Esempio su armadio / Wardrobe examples

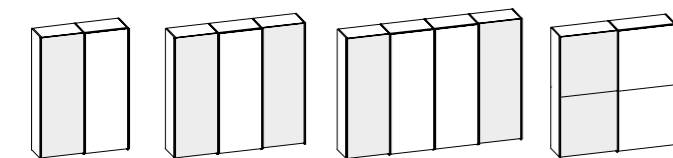

#### Esempio su armadio / Wardrobe examples

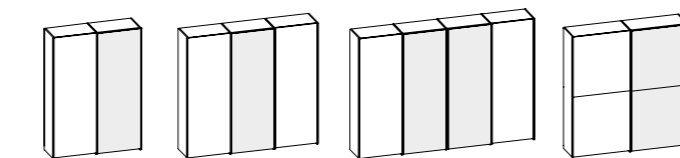

## BINARI RAILS

Gli armadi 2 ante scorrevoli sono predisposti di default per il montaggio con fianco P53 a sinistra e fianco P56,4 a destra e di conseguenza anta interna a sinistra e anta esterna a destra. Se per esigenze particolari si ha la necessità di invertire le ante, è possibile farlo montando il fianco P56,4 a sinistra e il P53 a destra. Va poi modificata anche l'installazione del binario superiore come da schema sotto.

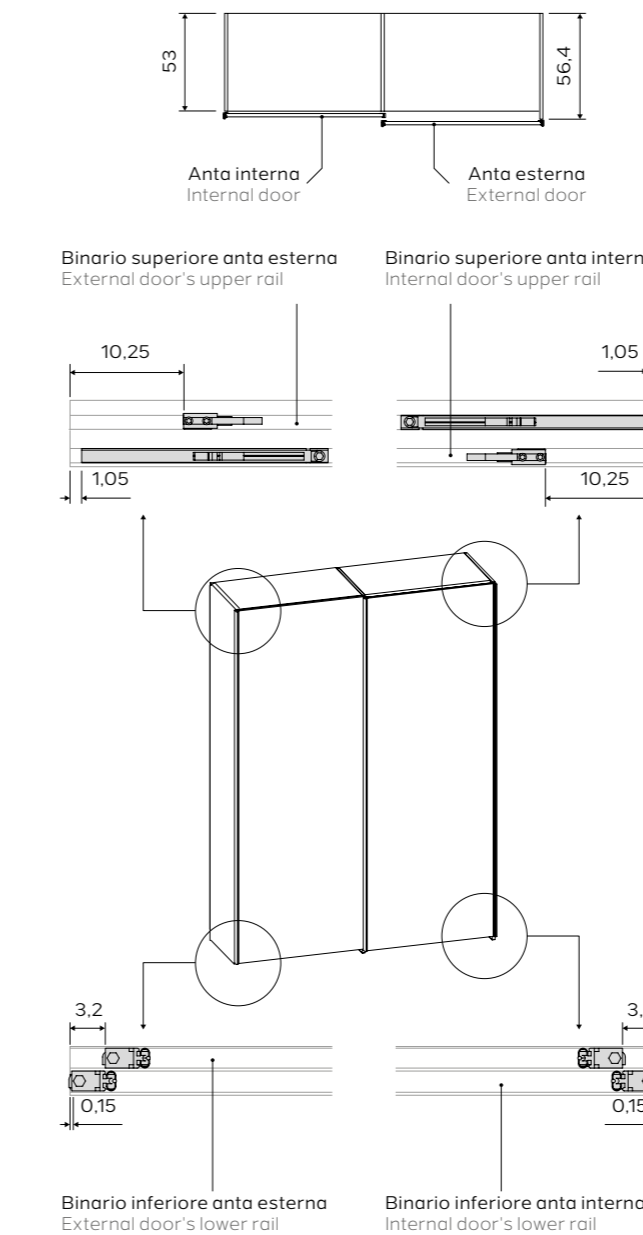

2 sliding doors wardrobes are assembled by default with P53 side to the left and P56.4 side to the right. As a result, the wardrobe will have the internal door on the left side and the external door on the right side. It's possible to invert this arrangement by reversing the sides and putting the P56.4 side to the left and the P53 side to the right. The upper rails must be installed as described below.

### MONTAGGIO STANDARD STANDARD ASSEMBLING

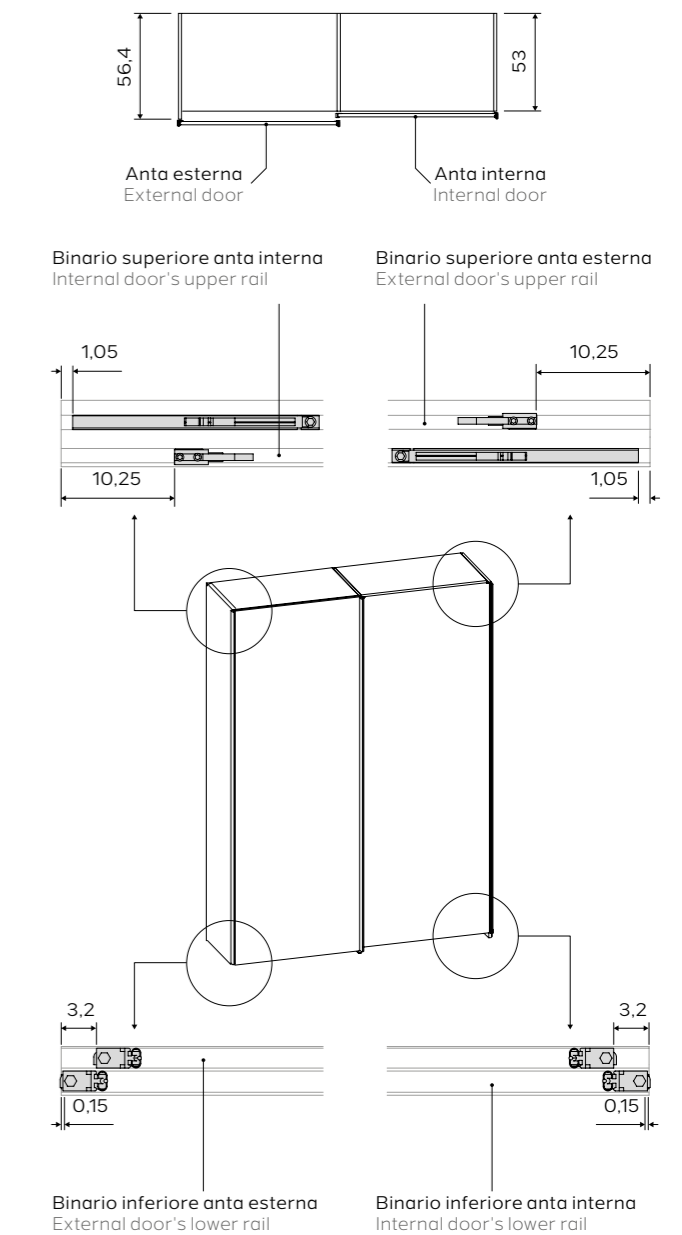

### MONTAGGIO INVERTITO INVERTED ASSEMBLING

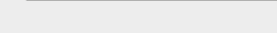

-  Finecorsa a pinza in apertura / pincer-shaped limit for opening
-  Fermo superiore ammortizzato in chiusura / upper stop with soft closing
-  Fermo per binario inferiore in apertura e chiusura / lower stop for opening and closing

# CARATTERISTICHE TECNICHE GRUPPI

## BEDROOM SETS TECHNICAL FEATURES

### CADY

#### Con maniglia M1 / With M1 handle

Maniglia L18,3/23,4 in MDF rivestito. essenza o bianco lucido.  
L18,3/23,4 handle in covered MDF. Wooden finishes and bianco lucido.

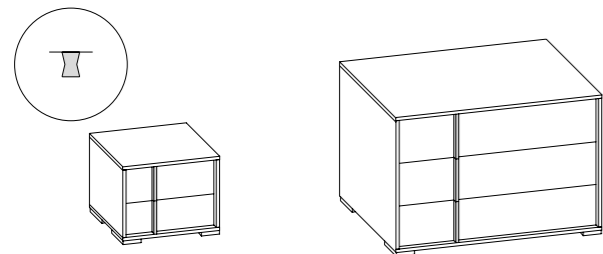

#### Informazioni tecniche / Technical information

- Prodotto fornito montato.
- Apertura con maniglia in MDF rivestito.
- Dotato di piedino fisso.
- In dotazione ferramenta antiribaltamento.
- Guide a rotella non ammortizzate con portata 30 kg.
- Disponibile kit ammortizzatore optional.
- Spessore cassa e frontali 18mm.
- Non si eseguono fuori misura.

- Delivered assembled.
- Opening with covered MDF handle.
- Equipped with fixed legs.
- Equipped with antitip hardware.
- Equipped with standard rails. Capacity: 30 kg.
- Optional soft closing rails.
- Structure and drawers thickness 18mm.
- Custom made elements aren't allowed.

#### Con maniglia M2 / With M2 handle

Maniglia L24,8/55 in MDF rivestito. Essenza o bianco lucido.  
L24,8/55 handle in covered MDF. Wooden finishes and bianco lucido.

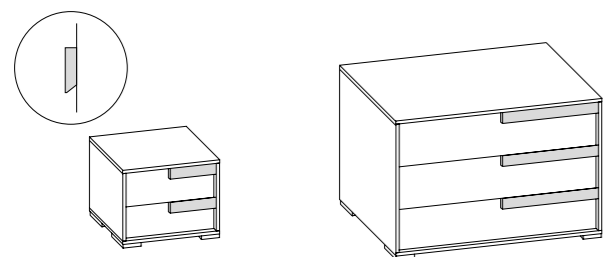

#### Misure / Measures

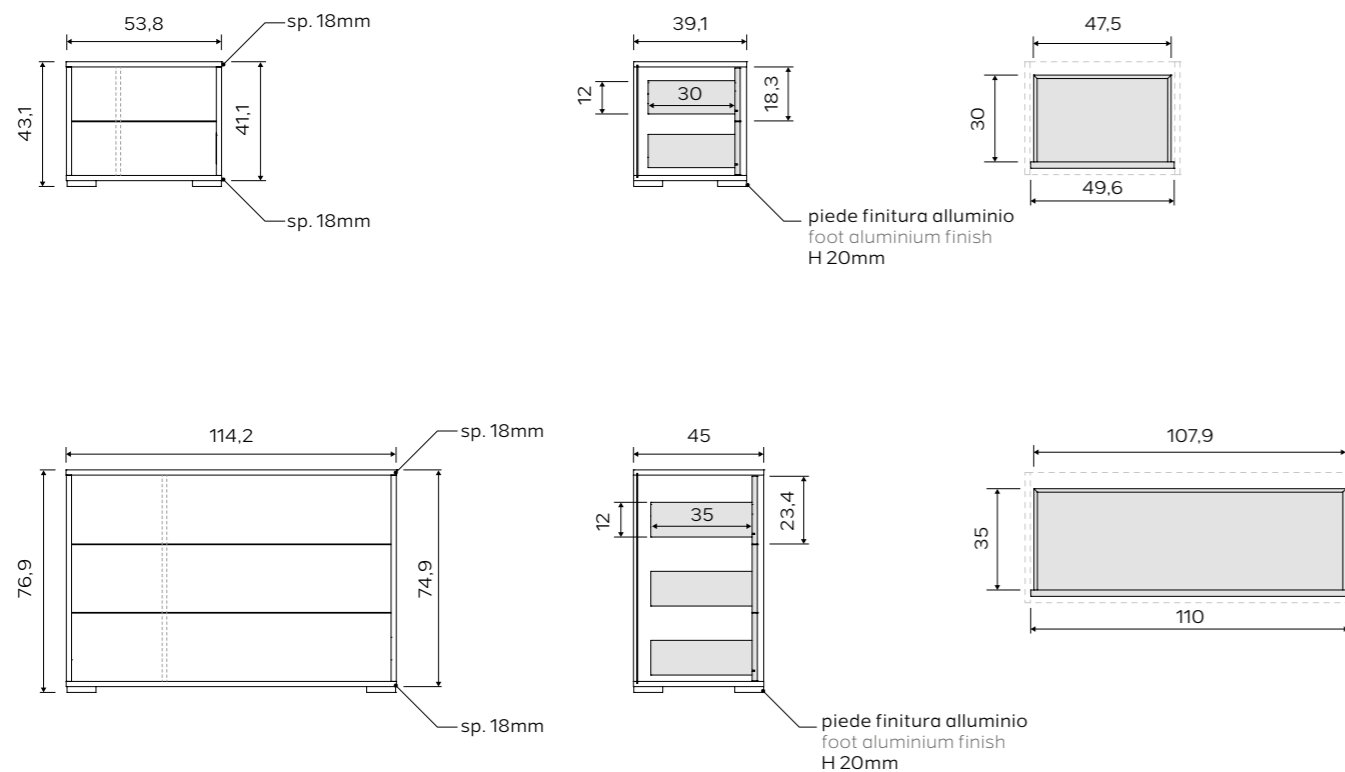

### SMALL

#### Con maniglia M1 / With M1 handle

Maniglia L18,2 in MDF rivestito. essenza o bianco lucido.  
L18,2 handle in covered MDF. Wooden finishes and bianco lucido.

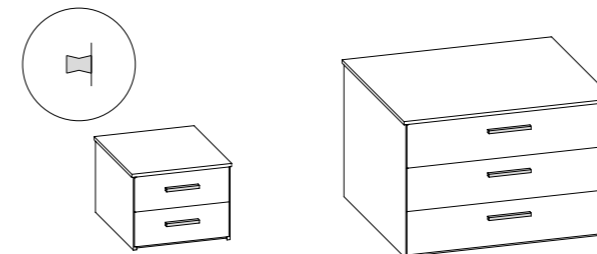

#### Informazioni tecniche / Technical information

- Prodotto fornito montato.
- Apertura con maniglia in MDF rivestito.
- Dotato di piedino fisso.
- In dotazione ferramenta antiribaltamento.
- Guide a rotella non ammortizzate con portata 30 kg.
- Disponibile kit ammortizzatore optional.
- Spessore cassa e frontali 18mm.
- Non si eseguono fuori misura.

- Delivered assembled.
- Opening with covered MDF handle.
- Equipped with fixed legs.
- Equipped with antitip hardware.
- Equipped with standard rails. Capacity: 30 kg.
- Optional soft closing rails.
- Structure and drawers thickness 18mm.
- Custom made elements aren't allowed.

#### Con maniglia M2 / With M2 handle

Maniglia L12/24,8 in MDF rivestito. Essenza o bianco lucido.  
L12/24,8 handle in covered MDF. Wooden finishes and bianco lucido.

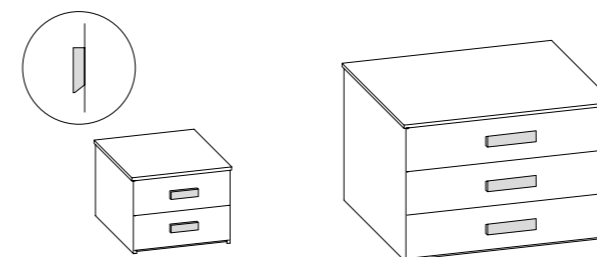

#### Misure / Measures

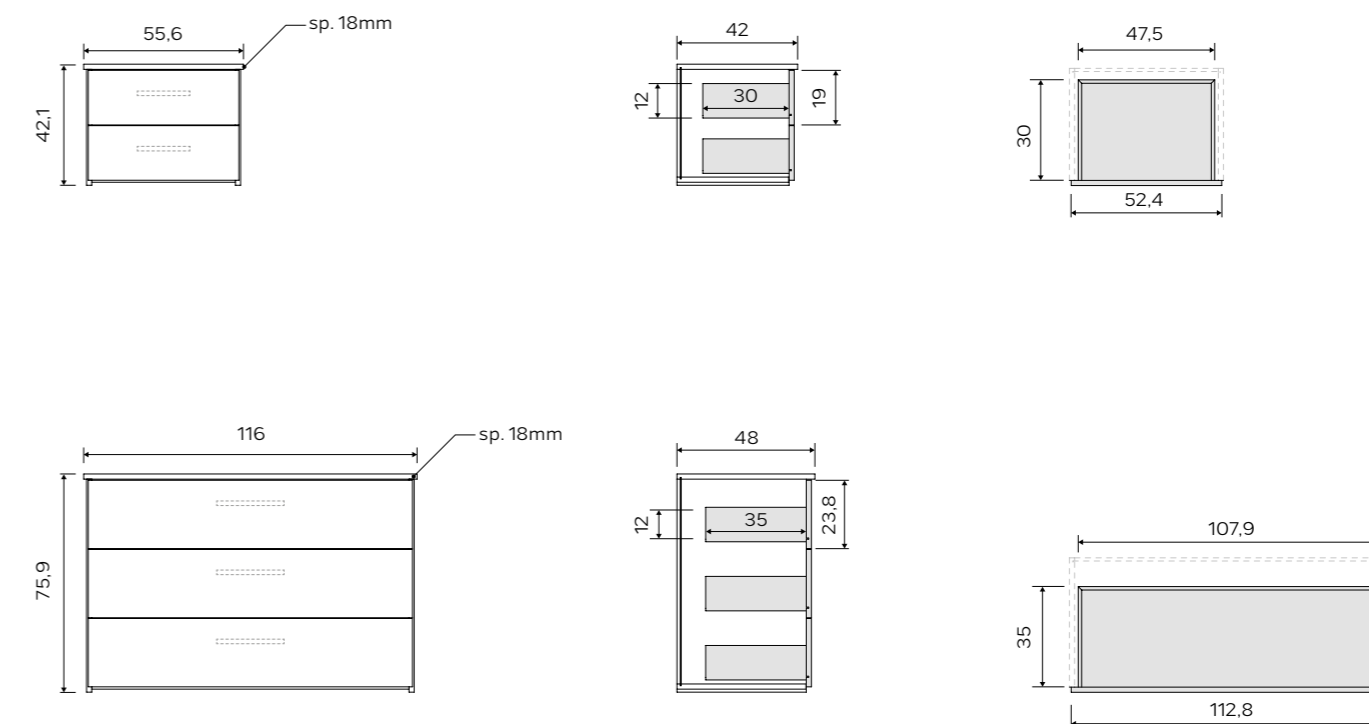

# CARATTERISTICHE TECNICHE GRUPPI

## BEDROOM SETS TECHNICAL FEATURES

### AUX

Senza maniglia / Without handle

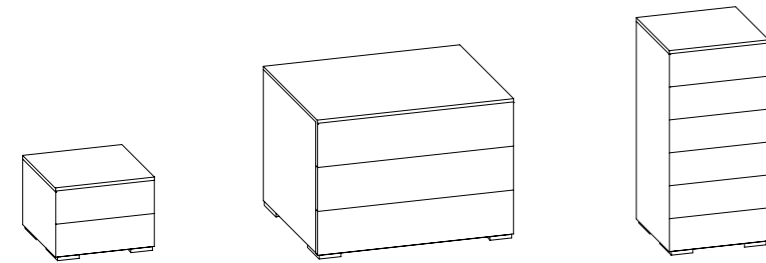

Informazioni tecniche / Technical information

- Prodotto fornito montato.
- Non sono previsti mix di finiture cassa e frontale.
- Apertura a presa laterale.
- Dotato di piedino fisso.
- In dotazione ferramenta antiribaltamento.
- Guide a rotella non ammortizzate con portata 30 kg.
- Spessore cassa e frontali 18mm.
- Non si eseguono fuori misura.

- Delivered assembled.
- Structure and drawers finish mixes are not available.
- Lateral opening.
- Equipped with fixed legs.
- Equipped with antitip hardware.
- Equipped with standard rails. Capacity: 30 kg.
- Structure and drawers thickness 18mm.
- Custom made elements aren't allowed.

Misure / Measures

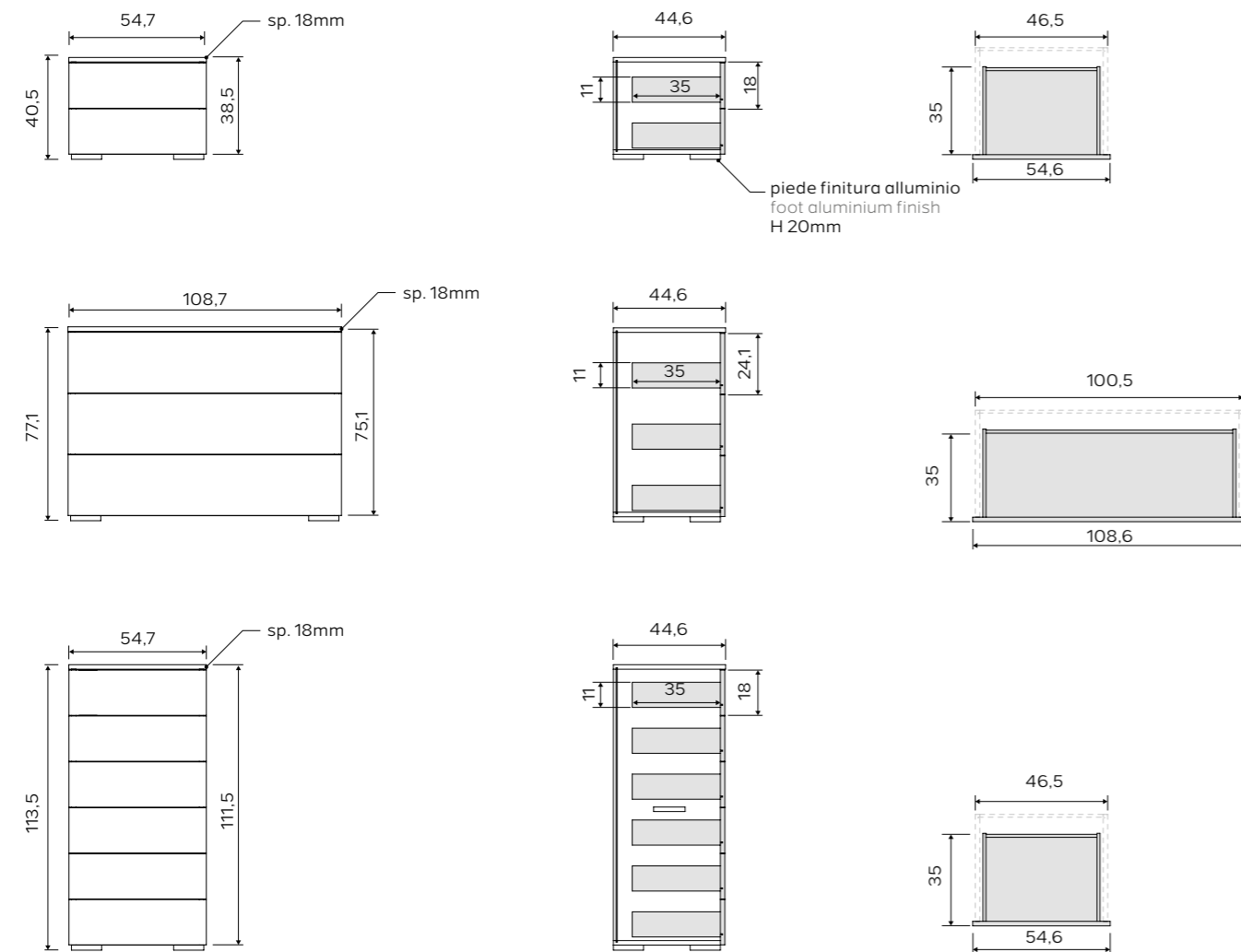

### LUX

Con maniglia M1 / With M1 handle

Maniglia L8 in MDF rivestito. Essenza o bianco lucido.  
L8 handle in covered MDF. Wooden finishes and bianco lucido.

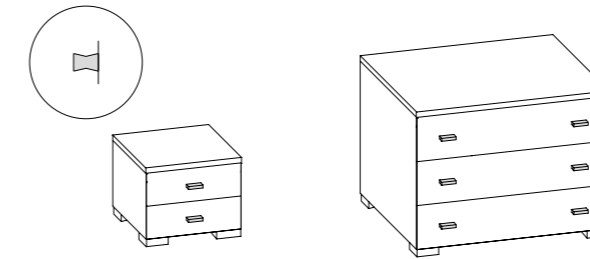

Informazioni tecniche / Technical information

- Prodotto fornito montato.
- Non sono previsti mix di finiture cassa e frontale.
- Apertura con maniglia in MDF rivestito.
- Dotato di piedino fisso.
- In dotazione ferramenta antiribaltamento.
- Guide a rotella non ammortizzate con portata 30 kg.
- Spessore cassa e frontali 18mm.
- Non si eseguono fuori misura.

- Delivered assembled.
- Structure and drawers finish mixes are not available.
- Opening with covered MDF handle.
- Equipped with fixed legs.
- Equipped with antitip hardware.
- Equipped with standard rails. Capacity: 30 kg.
- Structure and drawers thickness 18mm.
- Custom made elements aren't allowed.

Con maniglia M2 / With M2 handle

Maniglia L12 in MDF rivestito. Essenza o bianco lucido.  
L12 handle in covered MDF. Wooden finishes and bianco lucido.

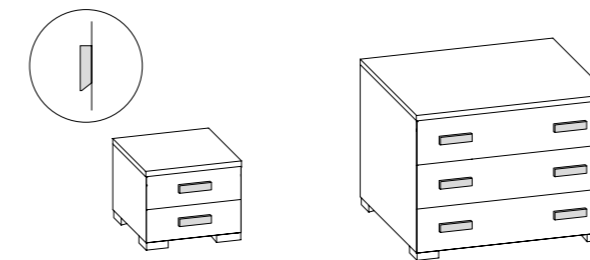

Misure / Measures

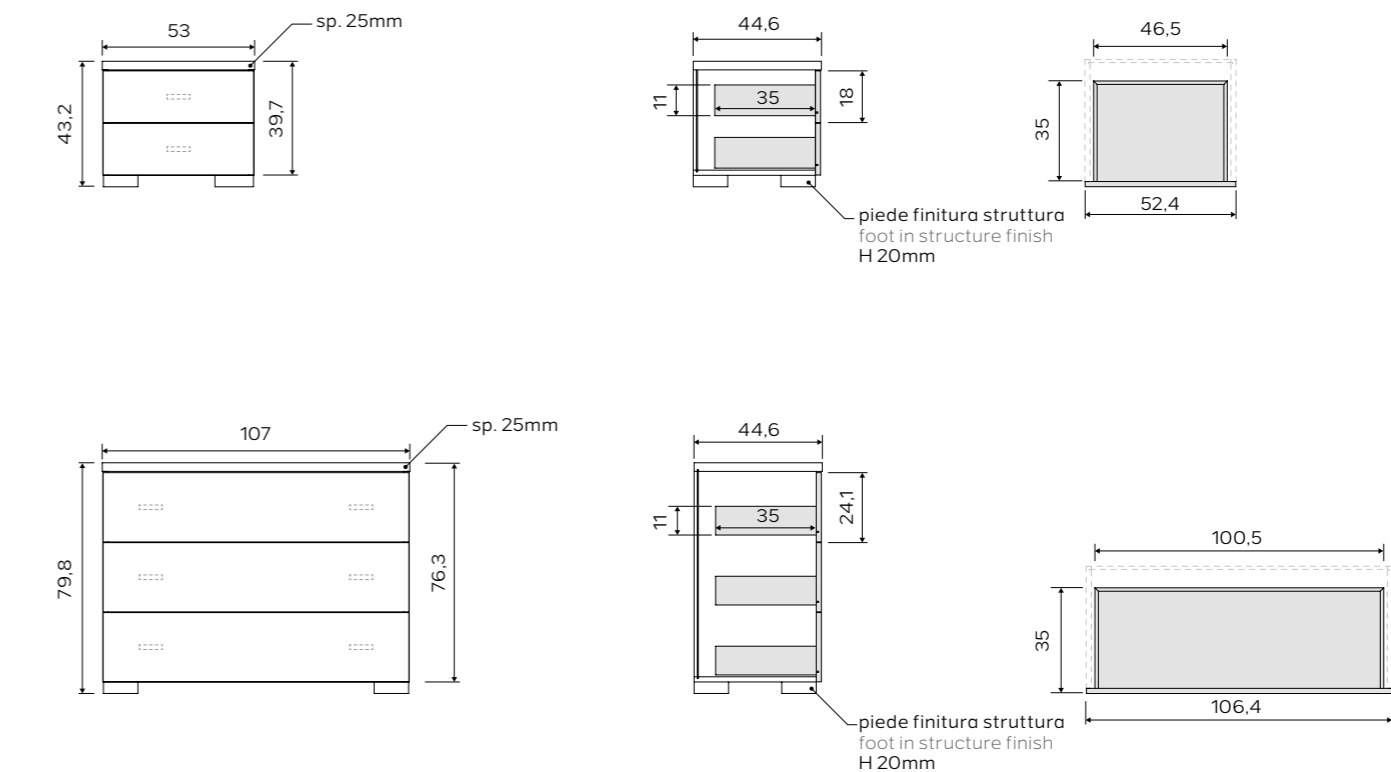

## CARATTERISTICHE TECNICHE GRUPPI

### BEDROOM SETS TECHNICAL FEATURES

#### THAI con vano a giorno / with open unit

Con maniglia dedicata / With dedicated handle

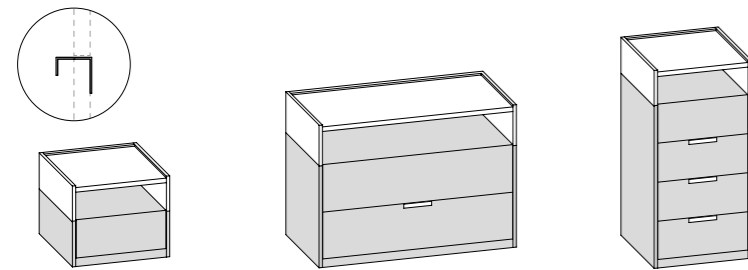

Informazioni tecniche / Technical information

- Prodotto fornito montato.
- Apertura con maniglia in metallo colore alluminio, presa superiore.
- Dotato di piedino fisso.
- In dotazione ferramenta antiribaltamento.
- Guide a rotella non ammortizzate con portata 30 kg.
- Disponibile kit ammortizzatore optional.
- Spessore cassa e frontali 18mm.
- Non si eseguono fuori misura.

- Delivered assembled.
- Opening with metal handle, aluminium finish.
- Equipped with fixed legs.
- Equipped with antitip hardware.
- Equipped with standard rails. Capacity: 30 kg.
- Optional soft closing rails.
- Structure and drawers thickness 18mm.
- Custom made elements aren't allowed.

Misure / Measures

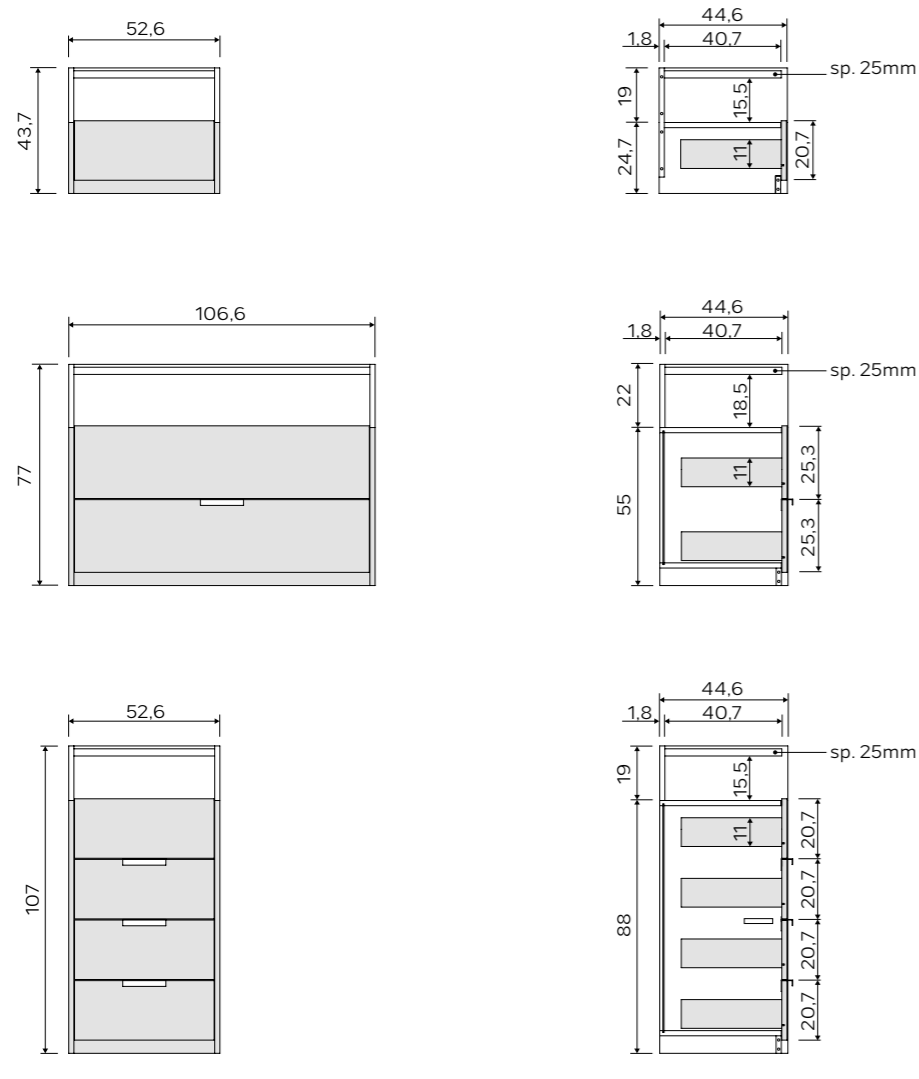

#### DUO

Con maniglia dedicata / With dedicated handle

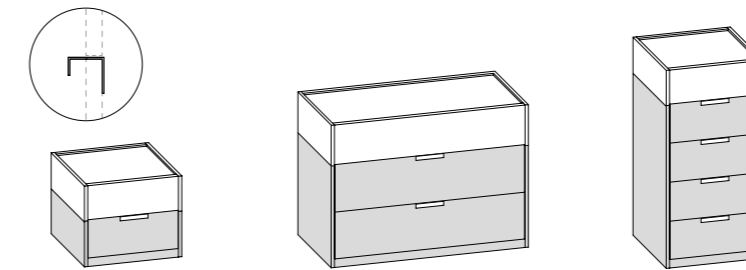

Informazioni tecniche / Technical information

- Prodotto fornito montato.
- Apertura con maniglia in metallo colore alluminio, presa superiore.
- Dotato di piedino fisso.
- In dotazione ferramenta antiribaltamento.
- Guide a rotella non ammortizzate con portata 30 kg.
- Disponibile kit ammortizzatore optional.
- Spessore cassa e frontali 18mm.
- Non si eseguono fuori misura.

- Delivered assembled.
- Opening with metal handle, aluminium finish.
- Equipped with fixed legs.
- Equipped with antitip hardware.
- Equipped with standard rails. Capacity: 30 kg.
- Optional soft closing rails.
- Structure and drawers thickness 18mm.
- Custom made elements aren't allowed.

Misure / Measures

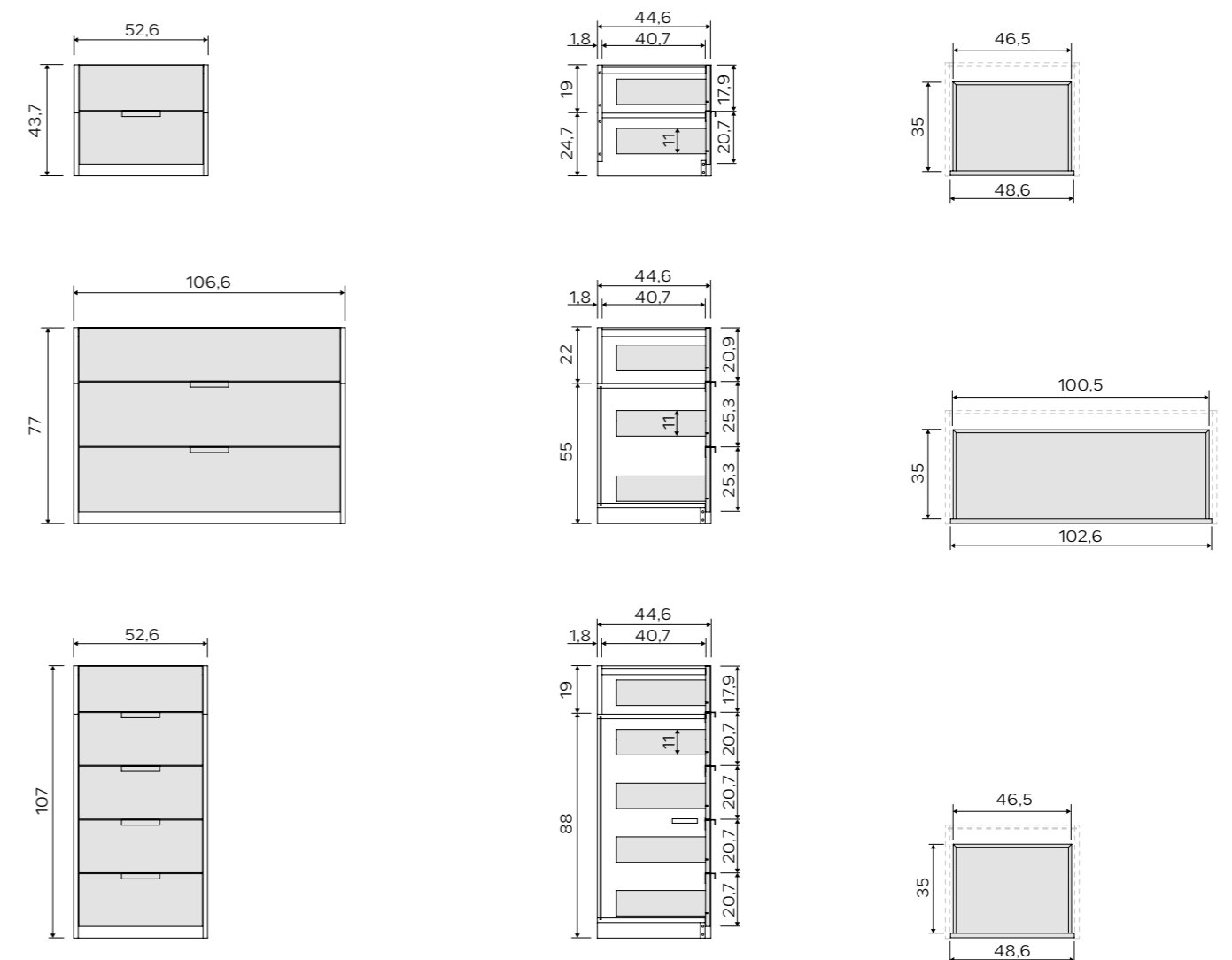



## CARATTERISTICHE TECNICHE GRUPPI

### BEDROOM SETS TECHNICAL FEATURES

#### SCRIVANIA / DESK

##### Informazioni tecniche / Technical information

- Disponibile con base frigo sia destra che sinistra.
- Anta dotata di pomolo in metallo, finitura titanio.

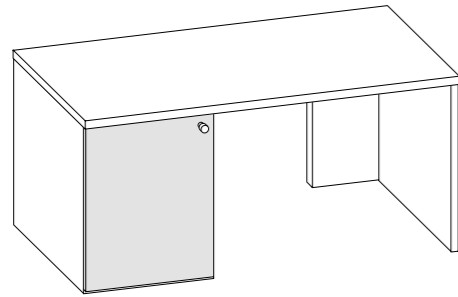

- Available in both right and left version.
- Door equipped with metal knob in titanium finish.

#### Misure / Measures

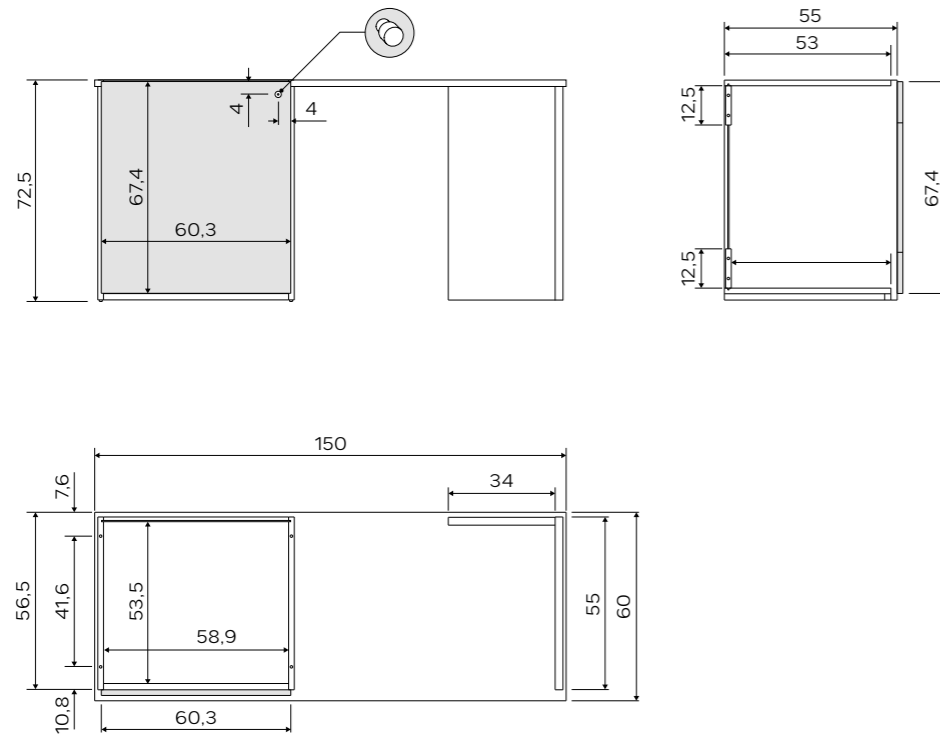

## CARATTERISTICHE TECNICHE LETTI LEGNO

### WOODEN BEDS TECHNICAL FEATURES

#### CARATTERISTICHE GIROLETTO GEMINI / GEMINI BEDFRAME FEATURES

- A Fondi contenitore / Bottom panels for bed with box**  
Fondi spessore 8mm in finitura Tessuto Grigio.  
Bottom panels 8mm in Tessuto Grigio finishing.
- B Tipologia rete / Bedspring type**  
Rete a doga unica.  
Bedspring with unique slat.
- C Lati giroletto / Bedframe sides**  
Giroletto 3 lati: i fascioni sono fissati alla testiera. Il giroletto per modello SLIM ha 4 lati.  
Bedframe with 3 sides: the bedframe sides are fixed to the headboard. The bedframe for SLIM bed has 4 sides instead of 3.
- D Angolari / Supports type**  
N.4 angolari divisi per supporto rete e unione giroletto e testiera.  
N.4 splitted supports for bedspring and junction between headboard and bedframe.
- E Misure giroletto GEMINI / GEMINI bedframe's measures**

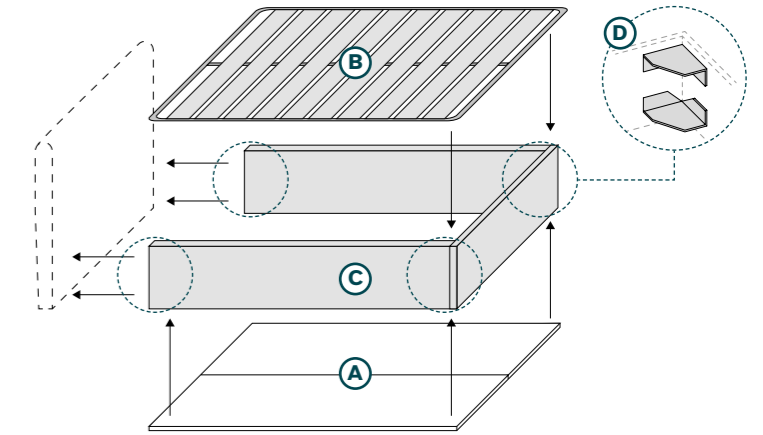

- F Piede P31 / P31 foot**

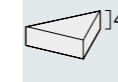

colore: alluminio / colour: aluminium

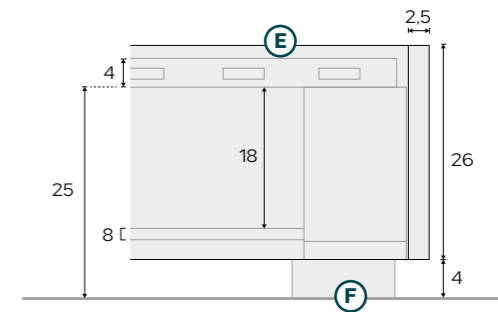

#### CARATTERISTICHE GIROLETTO GIGLIO / GIGLIO BEDFRAME FEATURES

- A Tipologia rete / Bedspring type**  
Rete a doga unica.  
Bedspring with unique slat.
- B Lati giroletto / Bedframe sides**  
Giroletto 3 lati: i fascioni sono fissati alla testiera.  
Bedframe with 3 sides: the bedframe sides are fixed to the headboard.
- C Angolari / Supports type**  
N.4 angolari per supporto rete e unione giroletto e testiera.  
N.4 supports for bedspring and junction between headboard and bedframe.
- E Misure giroletto GIGLIO / GIGLIO bedframe's measures**

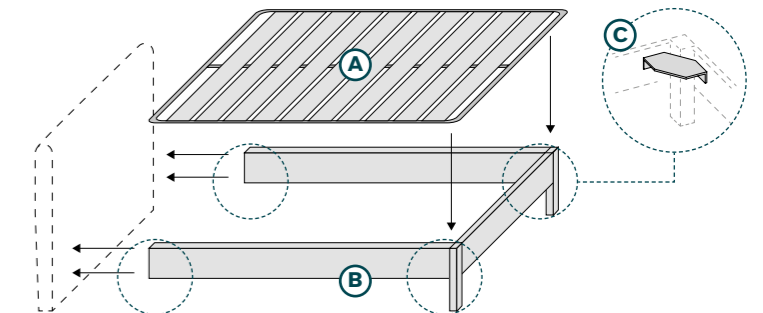

- F Piede P30 / P30 foot**

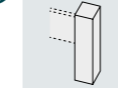

colore: come giroletto / colour: same colour of the bedframe

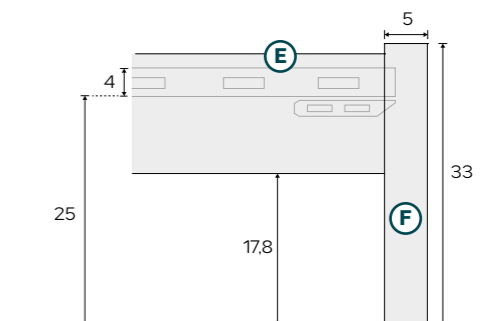

# CARATTERISTICHE TECNICHE LETTI LEGNO

## WOODEN BEDS TECHNICAL FEATURES

### REFLEX

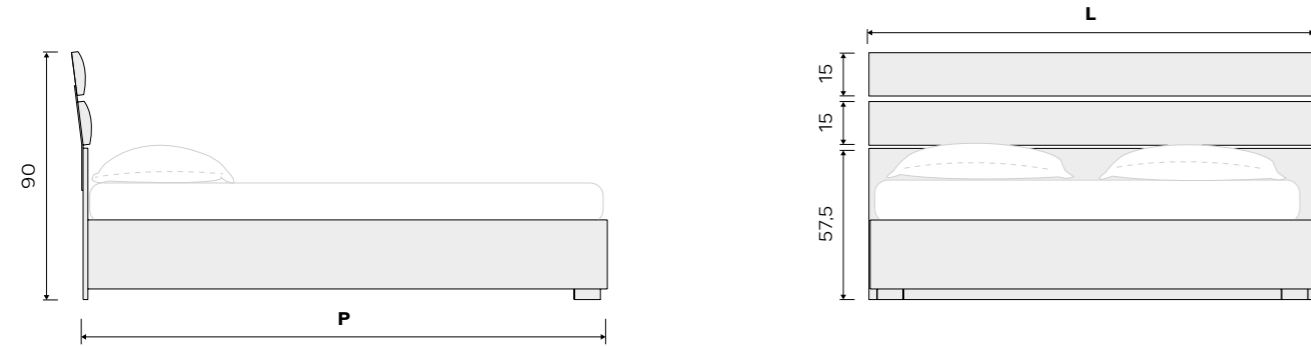

Giroletto GEMINI (3 lati) / GEMINI bedframe (3 sides)

Rete / Bedspring	L	P	Utile interno
160x190	169	205	162,5 x 193
160x200	169	215	162,5 x 203

### METIZ

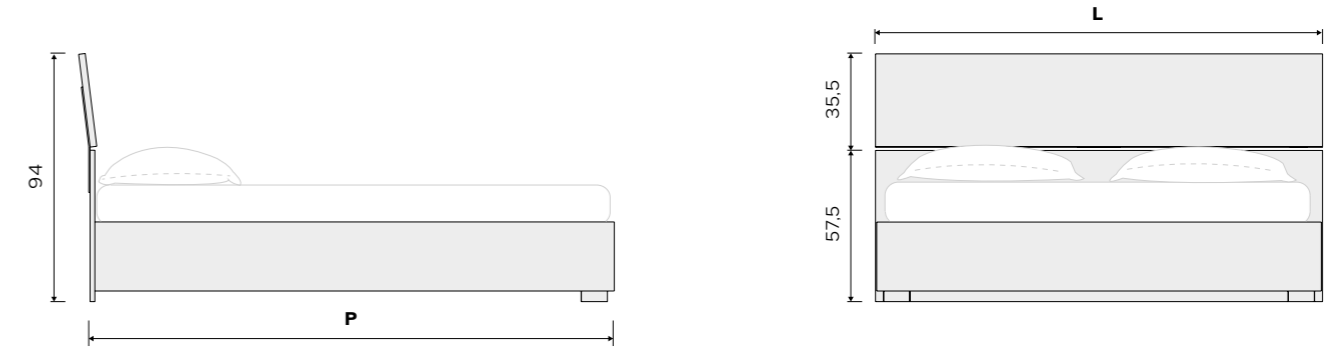

Giroletto GEMINI (3 lati) / GEMINI bedframe (3 sides)

Rete / Bedspring	L	P	Utile interno
160x190	169	202	162,5 x 193
160x200	169	212	162,5 x 203
180x200	189	212	182,5 x 203
150x190	159	202	152,5 x 193

Giroletto GIGLIO / GIGLIO bedframe

Rete / Bedspring	L	P	Utile interno
160x190	169	205	162,5 x 193

### VULCANO

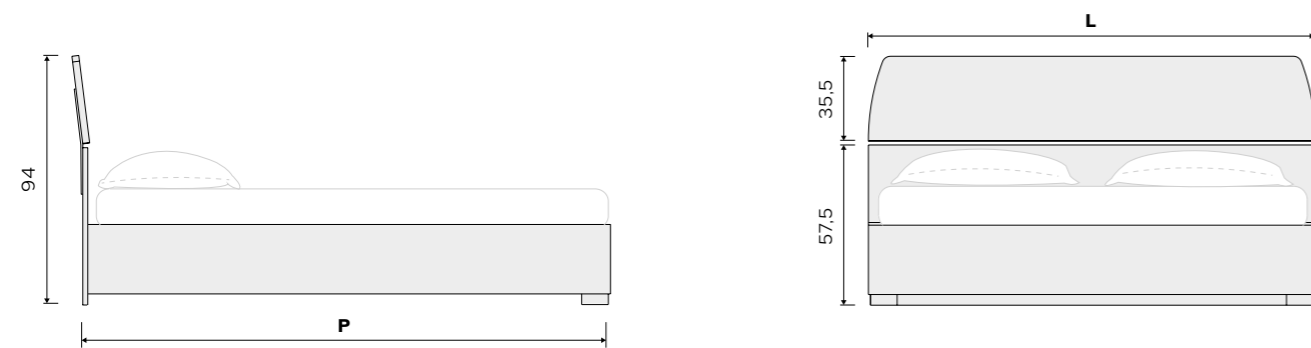

Giroletto GEMINI (3 lati) / GEMINI bedframe (3 sides)

Rete / Bedspring	L	P	Utile interno
160x190	169	205	162,5 x 193
160x200	169	215	162,5 x 203

### SLIM

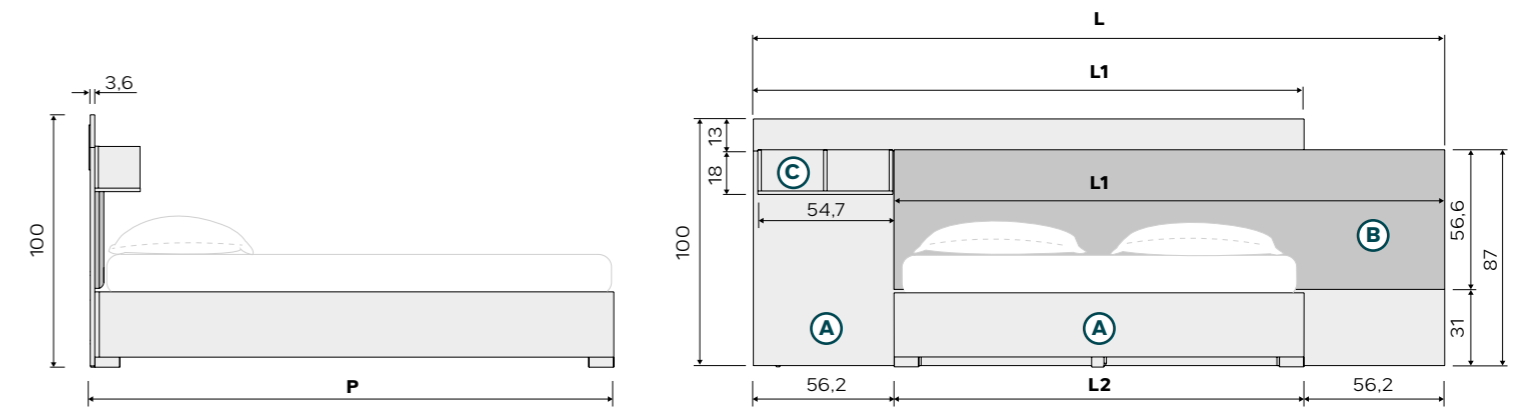

Giroletto GEMINI (4 lati) / GEMINI bedframe (4 sides)

Rete / Bedspring	L	L1	L2	P	Utile interno
160x190	280,2	223,2	167,6	200	162,5 x 193
160x200	280,2	223,2	167,6	210	162,5 x 203
180x200	300,2	243,2	187,6	210	182,5 x 203
150x190	270,2	213,2	157,6	200	152,5 x 193

- A** Letto Bed
- B** Pannello imbottito/legno: sempre posizionato a destra Upholstered or wooden panel: always on the right side
- C** Libreria optional Optional bookcase

## LETTI IMBOTTITI CON GIROLETTO 3 LATI G25

UPHOLSTERED BEDS WITH G25 BEDFRAME

### CARATTERISTICHE / FEATURES

**A Fondi contenitore /** Bottom panels for bed with box  
Fondi spessore 8mm in finitura Tessuto Grigio.  
Bottom panels 8mm in Tessuto Grigio finishing.

**B Tipologia rete /** Bedspring type  
Rete a doga unica.  
Bedspring with unique slat.

**C Lati giroletto /** Bedframe sides  
Giroletto 3 lati: i fascioni sono fissati alla testiera. L'interno dei giroletti imbottiti è rivestito con vellurina grigia.  
Bedframe with 3 sides: the bedframe sides are fixed to the headboard. The bedframe inner sides of upholstered bed frames are covered with a soft grey cloth.

**D Angolari /** Supports type  
N.4 angolari per supporto rete e unione giroletto e testiera.  
N.4 supports for bedspring and junction between headboard and bedframe.

**E Misure giroletto G25 /** G25 Bedframe's measures  
Tutti i letti imbottiti della collezione Facile 2.0 hanno come giroletto il modello G25, le cui misure sono descritte qui.  
The upholstered beds of this collection have G25 bedframe. Its measures are described here.

**F Piede P42 /** P42 foot



colore: nero / colour: black.

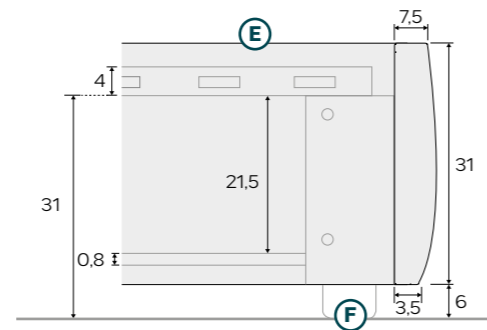
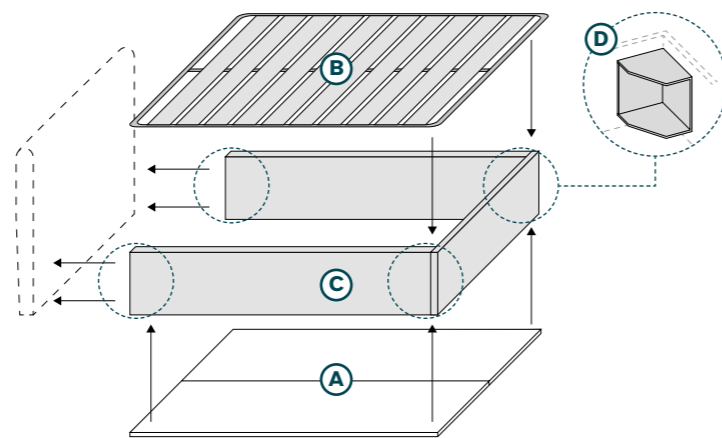

### MISAM

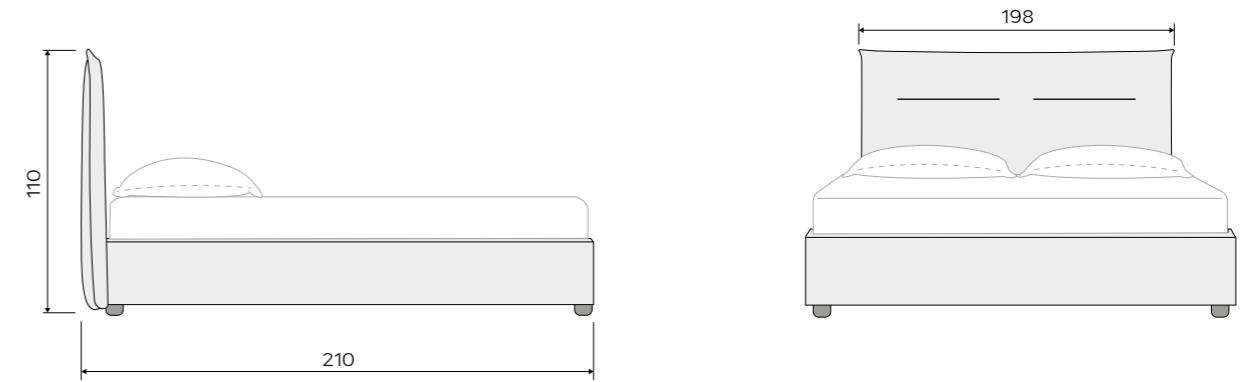

### RIGEL

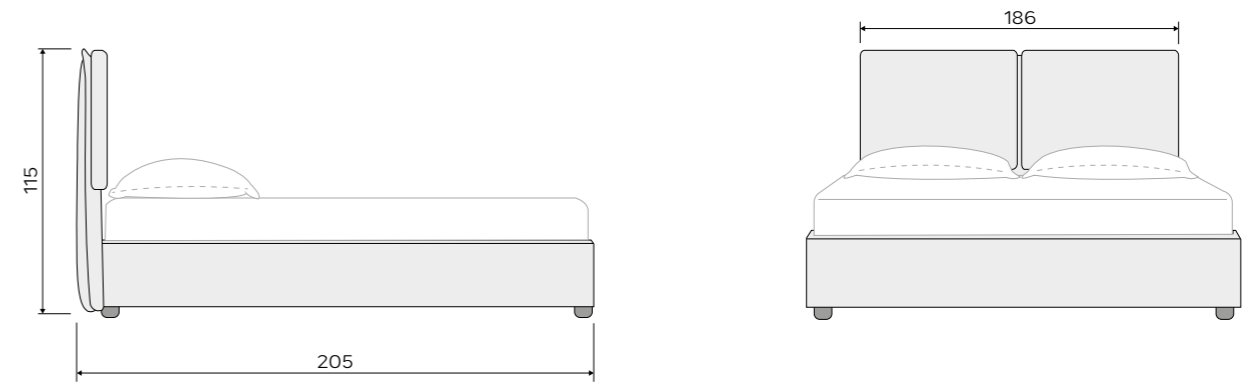

### ATIK



### DIONE BASIC

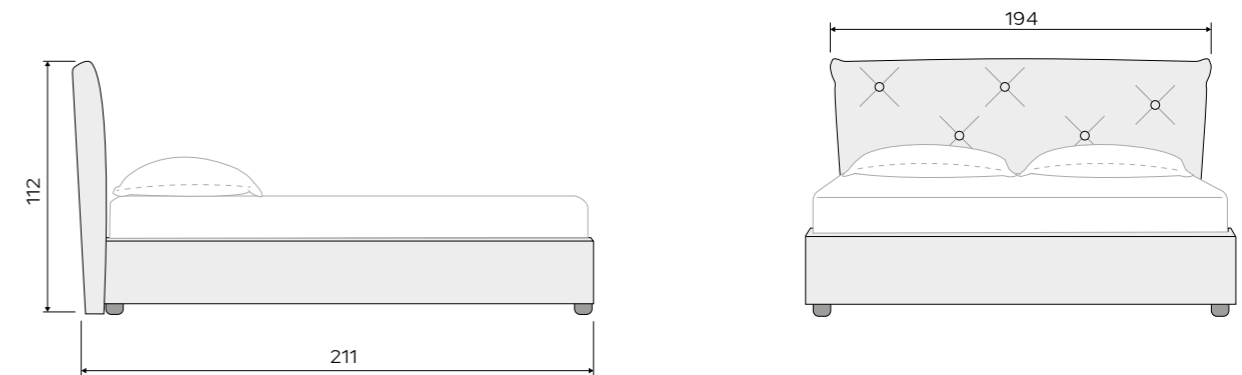

**LETTI IMBOTTITI CON GIROLETTO 3 LATI G25**  
UPHOLSTERED BEDS WITH G25 BEDFRAME

**ESEDRA BASIC**

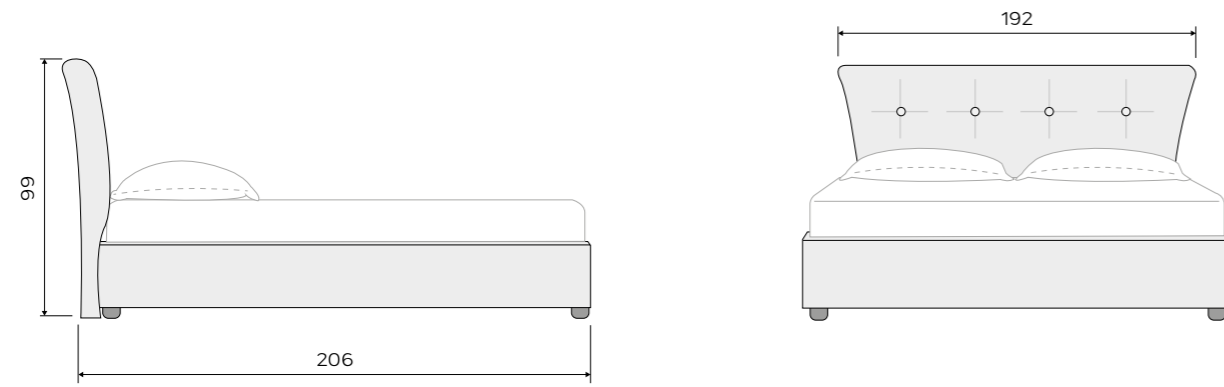

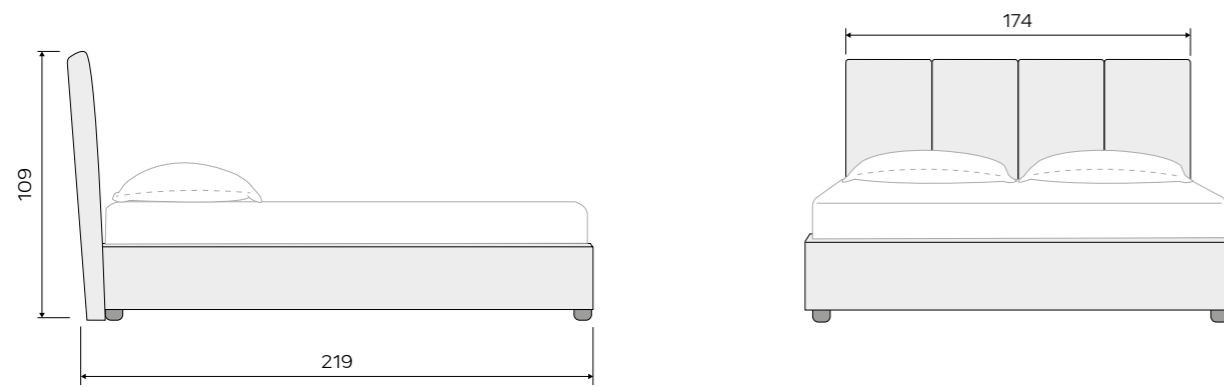

**ERA BASIC**



# PRICE LIST

# ARMADI BATTENTI H245

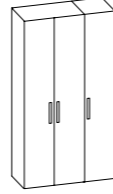
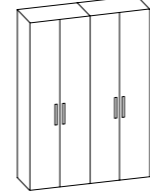
## HINGED WARDROBES H245

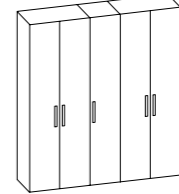
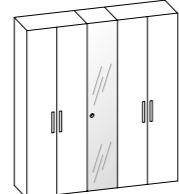
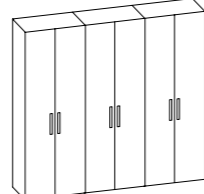
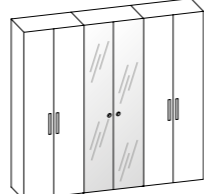
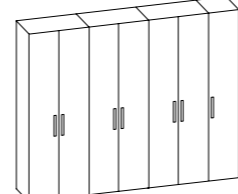
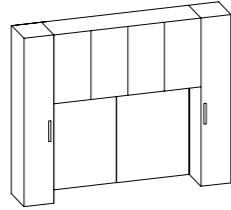
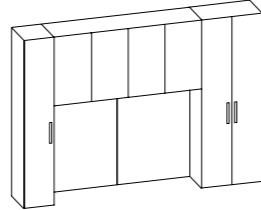
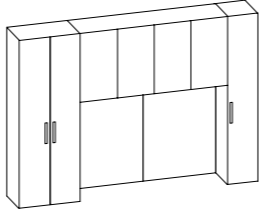
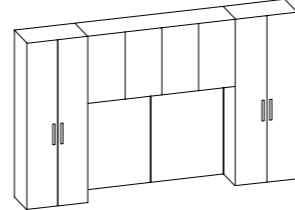
ARMADI LINEARI LINEAR WARDROBES		Armadio 1 ante 1 door wardrobe	Armadio 2 ante 2 doors wardrobe	Armadio 3 ante 3 doors wardrobe	Armadio 4 ante 4 doors wardrobe	Armadio 4 ante con 2 ante specchio 4 doors wardrobe with 2 mirror doors	Armadio 5 ante 5 doors wardrobe	COMBINAZIONI FINITURE FINISHES COMBINATIONS																																																								
<p>Completare il codice del prodotto con la sigla della <b>finitura</b> e della <b>maniglia</b> scelta. Complete the product code with the chosen finish and handle code.</p> <p><b>Maniglia:</b> stessa finitura della struttura.* Anta specchio con pomolo titanio. Handles of the same color of the structure.* Mirror door with titanium finish knob.</p>									<p><b>Nobilitato (NO + NO)</b></p> <table border="1"> <thead> <tr> <th>Cassa Structure</th> <th>Frontali Fronts</th> <th>Codice Code</th> </tr> </thead> <tbody> <tr><td rowspan="4">Bianco altea</td><td>Bianco altea</td><td><b>QQ</b></td></tr> <tr><td>Bianco nob.</td><td><b>QS</b></td></tr> <tr><td>Orzo</td><td><b>QD</b></td></tr> <tr><td>Argento</td><td><b>QU</b></td></tr> <tr><td rowspan="4">Oro</td><td>Oro</td><td><b>QT</b></td></tr> <tr><td>Olmo natura</td><td><b>BB</b></td></tr> <tr><td>Bianco nob.</td><td><b>BS</b></td></tr> <tr><td>Orzo</td><td><b>BD</b></td></tr> <tr><td rowspan="3">Argento</td><td>Argento</td><td><b>BU</b></td></tr> <tr><td>Oro</td><td><b>BT</b></td></tr> <tr><td>Noce biondo</td><td><b>RR</b></td></tr> <tr><td rowspan="4">Bianco nobilitato</td><td>Bianco nob.</td><td><b>RS</b></td></tr> <tr><td>Orzo</td><td><b>RD</b></td></tr> <tr><td>Argento</td><td><b>RU</b></td></tr> <tr><td>Oro</td><td><b>RT</b></td></tr> <tr><td rowspan="5">Orzo</td><td>Bianco altea</td><td><b>SQ</b></td></tr> <tr><td>Olmo natura</td><td><b>SB</b></td></tr> <tr><td>Noce biondo</td><td><b>SR</b></td></tr> <tr><td>Bianco nob.</td><td><b>SS</b></td></tr> <tr><td>Orzo</td><td><b>SD</b></td></tr> <tr><td rowspan="2">Argento</td><td>Argento</td><td><b>SU</b></td></tr> <tr><td>Oro</td><td><b>ST</b></td></tr> <tr><td>Orzo</td><td>Orzo</td><td><b>DD</b></td></tr> </tbody> </table>	Cassa Structure	Frontali Fronts	Codice Code	Bianco altea	Bianco altea	<b>QQ</b>	Bianco nob.	<b>QS</b>	Orzo	<b>QD</b>	Argento	<b>QU</b>	Oro	Oro	<b>QT</b>	Olmo natura	<b>BB</b>	Bianco nob.	<b>BS</b>	Orzo	<b>BD</b>	Argento	Argento	<b>BU</b>	Oro	<b>BT</b>	Noce biondo	<b>RR</b>	Bianco nobilitato	Bianco nob.	<b>RS</b>	Orzo	<b>RD</b>	Argento	<b>RU</b>	Oro	<b>RT</b>	Orzo	Bianco altea	<b>SQ</b>	Olmo natura	<b>SB</b>	Noce biondo	<b>SR</b>	Bianco nob.	<b>SS</b>	Orzo	<b>SD</b>	Argento	Argento	<b>SU</b>	Oro	<b>ST</b>	Orzo	Orzo
Cassa Structure	Frontali Fronts	Codice Code																																																														
Bianco altea	Bianco altea	<b>QQ</b>																																																														
	Bianco nob.	<b>QS</b>																																																														
	Orzo	<b>QD</b>																																																														
	Argento	<b>QU</b>																																																														
Oro	Oro	<b>QT</b>																																																														
	Olmo natura	<b>BB</b>																																																														
	Bianco nob.	<b>BS</b>																																																														
	Orzo	<b>BD</b>																																																														
Argento	Argento	<b>BU</b>																																																														
	Oro	<b>BT</b>																																																														
	Noce biondo	<b>RR</b>																																																														
Bianco nobilitato	Bianco nob.	<b>RS</b>																																																														
	Orzo	<b>RD</b>																																																														
	Argento	<b>RU</b>																																																														
	Oro	<b>RT</b>																																																														
Orzo	Bianco altea	<b>SQ</b>																																																														
	Olmo natura	<b>SB</b>																																																														
	Noce biondo	<b>SR</b>																																																														
	Bianco nob.	<b>SS</b>																																																														
	Orzo	<b>SD</b>																																																														
Argento	Argento	<b>SU</b>																																																														
	Oro	<b>ST</b>																																																														
Orzo	Orzo	<b>DD</b>																																																														
Struttura Structure	Frontali Fronts	L47,2 - P55 - H245	L92,6 - P55 - H245	L138 - P55 - H245	L183,4 - P55 - H245	L183,4 - P55 - H245	L228,8 - P55 - H245																																																									
		<b>RFB001</b> _ _ _	<b>RFB002</b> _ _ _	<b>RFB003</b> _ _ _	<b>RFB004</b> _ _ _	<b>RFB009</b> _ _ _	<b>RFB005</b> _ _ _																																																									
<b>NO</b>	<b>NO</b>	<b>175 €</b>	<b>220 €</b>	<b>342 €</b>	<b>379 €</b>	<b>432 €</b>	<b>488 €</b>																																																									
<b>NO</b>	<b>LC</b>	<b>191 €</b>	<b>248 €</b>	<b>387 €</b>	<b>436 €</b>	<b>478 €</b>	<b>552 €</b>																																																									
<b>LC</b>	<b>LC</b>	<b>227 €</b>	<b>284 €</b>	<b>425 €</b>	<b>474 €</b>	<b>526 €</b>	<b>590 €</b>																																																									
ARMADI LINEARI LINEAR WARDROBES		Armadio 5 ante con 1 ante specchio 5 doors wardrobe with 1 mirror door	Armadio 6 ante 6 doors wardrobe	Armadio 6 ante con 2 ante specchio 6 doors wardrobe with 2 mirror doors	Armadio 7 ante 7 doors wardrobe	Armadio 8 ante 8 doors wardrobe		<p><b>Nobilitato e laccato (NO + LC)</b></p> <table border="1"> <thead> <tr> <th>Cassa Structure</th> <th>Frontali Fronts</th> <th>Codice Code</th> </tr> </thead> <tbody> <tr><td>Bianco altea</td><td>Bianco lucido</td><td><b>QE</b></td></tr> <tr><td>Olmo natura</td><td>Bianco lucido</td><td><b>BE</b></td></tr> <tr><td>Noce biondo</td><td>Bianco lucido</td><td><b>RE</b></td></tr> </tbody> </table> <p><b>Laccato (LC + LC)</b></p> <table border="1"> <thead> <tr> <th>Cassa Structure</th> <th>Frontali Fronts</th> <th>Codice Code</th> </tr> </thead> <tbody> <tr><td>Bianco lucido</td><td>Bianco lucido</td><td><b>EE</b></td></tr> </tbody> </table>	Cassa Structure	Frontali Fronts	Codice Code	Bianco altea	Bianco lucido	<b>QE</b>	Olmo natura	Bianco lucido	<b>BE</b>	Noce biondo	Bianco lucido	<b>RE</b>	Cassa Structure	Frontali Fronts	Codice Code	Bianco lucido	Bianco lucido	<b>EE</b>																																						
Cassa Structure	Frontali Fronts	Codice Code																																																														
Bianco altea	Bianco lucido	<b>QE</b>																																																														
Olmo natura	Bianco lucido	<b>BE</b>																																																														
Noce biondo	Bianco lucido	<b>RE</b>																																																														
Cassa Structure	Frontali Fronts	Codice Code																																																														
Bianco lucido	Bianco lucido	<b>EE</b>																																																														
<p>Completare il codice del prodotto con la sigla della <b>finitura</b> e della <b>maniglia</b> scelta. Complete the product code with the chosen finish and handle code.</p> <p><b>Maniglia:</b> stessa finitura della struttura.* Anta specchio con pomolo titanio. Handles of the same color of the structure.* Mirror door with titanium finish knob.</p>																																																																
Struttura Structure	Frontali Fronts	L228,8 - P55 - H245	L274,2 - P55 - H245	L274,2 - P55 - H245	L319,6 - P55 - H245	L365 - P55 - H245																																																										
		<b>RFB010</b> _ _ _	<b>RFB006</b> _ _ _	<b>RFB011</b> _ _ _	<b>RFB007</b> _ _ _	<b>RFB008</b> _ _ _																																																										
<b>NO</b>	<b>NO</b>	<b>514 €</b>	<b>522 €</b>	<b>597 €</b>	<b>717 €</b>	<b>765 €</b>																																																										
<b>NO</b>	<b>LC</b>	<b>578 €</b>	<b>607 €</b>	<b>635 €</b>	<b>822 €</b>	<b>882 €</b>																																																										
<b>LC</b>	<b>LC</b>	<b>616 €</b>	<b>635 €</b>	<b>664 €</b>	<b>859 €</b>	<b>919 €</b>																																																										
PONTI BRIDGE UNITS		Ponte con 2 vani da 45 Bridge unit with 2 L45 units	Ponte con un vano da 45 e uno da 90 Bridge unit with L45 and L90 units	Ponte con un vano da 45 e uno da 90 Bridge unit with L45 and L90 units	Ponte con 2 vani da 90 Bridge unit with 2 L90 units			<p><b>MANIGLIE / HANDLES</b></p> <table border="1"> <thead> <tr> <th>Modello Model</th> <th>Codice Code</th> </tr> </thead> <tbody> <tr><td>Maniglia 1</td><td><b>M1</b></td></tr> <tr><td>Maniglia 2</td><td><b>M2</b></td></tr> </tbody> </table>	Modello Model	Codice Code	Maniglia 1	<b>M1</b>	Maniglia 2	<b>M2</b>																																																		
Modello Model	Codice Code																																																															
Maniglia 1	<b>M1</b>																																																															
Maniglia 2	<b>M2</b>																																																															
<p>Completare il codice del prodotto con la sigla della <b>finitura</b> e della <b>maniglia</b> scelta. Complete the product code with the chosen finish and handle code.</p> <p><b>Maniglia:</b> stessa finitura della struttura.* Handles of the same color of the structure.*</p>																																																																
Struttura Structure	Frontali Fronts	L319,6 - P55 - H245	L365 - P55 - H245	L365 - P55 - H245	L410,4 - P55 - H245																																																											
		<b>RFB018</b> _ _ _	<b>RFB019</b> _ _ _	<b>RFB020</b> _ _ _	<b>RFB029</b> _ _ _																																																											
<b>NO</b>	<b>NO</b>	<b>758 €</b>	<b>834 €</b>	<b>834 €</b>	<b>879 €</b>																																																											
<b>NO</b>	<b>LC</b>	<b>815 €</b>	<b>910 €</b>	<b>910 €</b>	<b>967 €</b>																																																											
<b>LC</b>	<b>LC</b>	-	-	-	-																																																											

## ARMADI BATTENTI SPECIALI H245

### SPECIAL HINGED WARDROBES H245

ANGOLI CORNER UNITS		Angolo Corner unit	COMBINAZIONI FINITURE FINISHES COMBINATIONS																																																							
<p>Completare il codice del prodotto con la sigla della <b>finitura</b> e della <b>maniglia</b> scelta. Complete the product code with the chosen finish and handle code.</p> <p><b>Maniglia:</b> stessa finitura della struttura.* Handles of the same color of the structure.*</p>		 <p>L86,2 - P86,2 - H245</p>	<p><b>Nobilitato (NO + NO)</b></p> <table border="1"> <thead> <tr> <th>Cassa Structure</th> <th>Frontali Fronts</th> <th>Codice Code</th> </tr> </thead> <tbody> <tr><td rowspan="5">Bianco altea</td><td>Bianco altea</td><td><b>QQ</b></td></tr> <tr><td>Bianco nob.</td><td><b>QS</b></td></tr> <tr><td>Orzo</td><td><b>QD</b></td></tr> <tr><td>Argento</td><td><b>QU</b></td></tr> <tr><td>Oro</td><td><b>QT</b></td></tr> <tr><td rowspan="5">Olmo natura</td><td>Olmo natura</td><td><b>BB</b></td></tr> <tr><td>Bianco nob.</td><td><b>BS</b></td></tr> <tr><td>Orzo</td><td><b>BD</b></td></tr> <tr><td>Argento</td><td><b>BU</b></td></tr> <tr><td>Oro</td><td><b>BT</b></td></tr> <tr><td rowspan="5">Noce biondo</td><td>Noce biondo</td><td><b>RR</b></td></tr> <tr><td>Bianco nob.</td><td><b>RS</b></td></tr> <tr><td>Orzo</td><td><b>RD</b></td></tr> <tr><td>Argento</td><td><b>RU</b></td></tr> <tr><td>Oro</td><td><b>RT</b></td></tr> <tr><td rowspan="5">Bianco nobilitato</td><td>Bianco altea</td><td><b>SQ</b></td></tr> <tr><td>Olmo natura</td><td><b>SB</b></td></tr> <tr><td>Noce biondo</td><td><b>SR</b></td></tr> <tr><td>Bianco nob.</td><td><b>SS</b></td></tr> <tr><td>Orzo</td><td><b>SD</b></td></tr> <tr><td rowspan="3">Orzo</td><td>Argento</td><td><b>SU</b></td></tr> <tr><td>Oro</td><td><b>ST</b></td></tr> <tr><td>Orzo</td><td><b>DD</b></td></tr> </tbody> </table>		Cassa Structure	Frontali Fronts	Codice Code	Bianco altea	Bianco altea	<b>QQ</b>	Bianco nob.	<b>QS</b>	Orzo	<b>QD</b>	Argento	<b>QU</b>	Oro	<b>QT</b>	Olmo natura	Olmo natura	<b>BB</b>	Bianco nob.	<b>BS</b>	Orzo	<b>BD</b>	Argento	<b>BU</b>	Oro	<b>BT</b>	Noce biondo	Noce biondo	<b>RR</b>	Bianco nob.	<b>RS</b>	Orzo	<b>RD</b>	Argento	<b>RU</b>	Oro	<b>RT</b>	Bianco nobilitato	Bianco altea	<b>SQ</b>	Olmo natura	<b>SB</b>	Noce biondo	<b>SR</b>	Bianco nob.	<b>SS</b>	Orzo	<b>SD</b>	Orzo	Argento	<b>SU</b>	Oro	<b>ST</b>	Orzo	<b>DD</b>
Cassa Structure	Frontali Fronts	Codice Code																																																								
Bianco altea	Bianco altea	<b>QQ</b>																																																								
	Bianco nob.	<b>QS</b>																																																								
	Orzo	<b>QD</b>																																																								
	Argento	<b>QU</b>																																																								
	Oro	<b>QT</b>																																																								
Olmo natura	Olmo natura	<b>BB</b>																																																								
	Bianco nob.	<b>BS</b>																																																								
	Orzo	<b>BD</b>																																																								
	Argento	<b>BU</b>																																																								
	Oro	<b>BT</b>																																																								
Noce biondo	Noce biondo	<b>RR</b>																																																								
	Bianco nob.	<b>RS</b>																																																								
	Orzo	<b>RD</b>																																																								
	Argento	<b>RU</b>																																																								
	Oro	<b>RT</b>																																																								
Bianco nobilitato	Bianco altea	<b>SQ</b>																																																								
	Olmo natura	<b>SB</b>																																																								
	Noce biondo	<b>SR</b>																																																								
	Bianco nob.	<b>SS</b>																																																								
	Orzo	<b>SD</b>																																																								
Orzo	Argento	<b>SU</b>																																																								
	Oro	<b>ST</b>																																																								
	Orzo	<b>DD</b>																																																								
Struttura Structure	Frontali Fronts	<b>RFB012</b> _ _ _																																																								
<b>NO</b>	<b>NO</b>	<b>313 €</b>																																																								
<b>NO</b>	<b>LC</b>	<b>329 €</b>																																																								
<b>LC</b>	<b>LC</b>	<b>351 €</b>																																																								

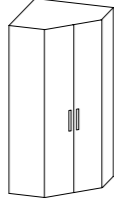
CABINE CLOTHES CLOSET UNITS		Cabina Clothes closet unit	COMBINAZIONI FINITURE FINISHES COMBINATIONS													
<p>Completare il codice del prodotto con la sigla della <b>finitura</b> e della <b>maniglia</b> scelta. Complete the product code with the chosen finish and handle code.</p> <p><b>Maniglia:</b> stessa finitura della struttura.* Handles of the same color of the structure.*</p>		 <p>L118,9 - P118,9 - H245</p>	<p><b>Nobilitato e laccato (NO + LC)</b></p> <table border="1"> <thead> <tr> <th>Cassa Structure</th> <th>Frontali Fronts</th> <th>Codice Code</th> </tr> </thead> <tbody> <tr><td>Bianco altea</td><td>Bianco lucido</td><td><b>QE</b></td></tr> <tr><td>Olmo natura</td><td>Bianco lucido</td><td><b>BE</b></td></tr> <tr><td>Noce biondo</td><td>Bianco lucido</td><td><b>RE</b></td></tr> </tbody> </table>		Cassa Structure	Frontali Fronts	Codice Code	Bianco altea	Bianco lucido	<b>QE</b>	Olmo natura	Bianco lucido	<b>BE</b>	Noce biondo	Bianco lucido	<b>RE</b>
Cassa Structure	Frontali Fronts	Codice Code														
Bianco altea	Bianco lucido	<b>QE</b>														
Olmo natura	Bianco lucido	<b>BE</b>														
Noce biondo	Bianco lucido	<b>RE</b>														
Struttura Structure	Frontali Fronts	<b>RFB013</b> _ _ _														
<b>NO</b>	<b>NO</b>	<b>427 €</b>														
<b>NO</b>	<b>LC</b>	<b>502 €</b>														
<b>LC</b>	<b>LC</b>	<b>525 €</b>														

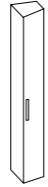
TERMINALI END UNITS		Terminale sinistro Left end unit	Terminale destro Right end unit	COMBINAZIONI FINITURE FINISHES COMBINATIONS							
<p>Completare il codice del prodotto con la sigla della <b>finitura</b> e della <b>maniglia</b> scelta. Complete the product code with the chosen finish and handle code.</p> <p><b>Maniglia:</b> stessa finitura della struttura.* Handles of the same color of the structure.*</p>		 <p>L41,2 - P55 - H245</p>	 <p>L41,2 - P55 - H245</p>	<p><b>Laccato (LC + LC)</b></p> <table border="1"> <thead> <tr> <th>Cassa Structure</th> <th>Frontali Fronts</th> <th>Codice Code</th> </tr> </thead> <tbody> <tr><td>Bianco lucido</td><td>Bianco lucido</td><td><b>EE</b></td></tr> </tbody> </table>		Cassa Structure	Frontali Fronts	Codice Code	Bianco lucido	Bianco lucido	<b>EE</b>
Cassa Structure	Frontali Fronts	Codice Code									
Bianco lucido	Bianco lucido	<b>EE</b>									
Struttura Structure	Frontali Fronts	<b>RFB017</b> _ _ _	<b>RFB016</b> _ _ _								
<b>NO</b>	<b>NO</b>	<b>218 €</b>	<b>218 €</b>								
<b>NO</b>	<b>LC</b>	<b>229 €</b>	<b>229 €</b>								
<b>LC</b>	<b>LC</b>	<b>251 €</b>	<b>251 €</b>								

## ARMADI BATTENTI SPECIALI CON ANTA SPECCHIO H245

### SPECIAL HINGED WARDROBES WITH MIRROR DOORS H245

ANGOLI CORNER UNITS		Angolo con anta specchio Corner unit with mirror door	COMBINAZIONI FINITURE FINISHES COMBINATIONS																			
<p>Completare il codice del prodotto con la sigla della <b>finitura</b> scelta. Complete the product code with the chosen finish code.</p> <p><b>Maniglia:</b> pomolo titanio. Handle: titanium finish knob.</p>		 <p>L86,2 - P86,2 - H245</p>	<p><b>Nobilitato (NO + NO)</b></p> <table border="1"> <thead> <tr> <th>Cassa Structure</th> <th>Frontali Fronts</th> <th>Codice Code</th> </tr> </thead> <tbody> <tr><td>Bianco altea</td><td>Specchio</td><td><b>QH</b></td></tr> <tr><td>Olmo natura</td><td>Specchio</td><td><b>BH</b></td></tr> <tr><td>Noce biondo</td><td>Specchio</td><td><b>RH</b></td></tr> <tr><td>Bianco nob.</td><td>Specchio</td><td><b>SH</b></td></tr> <tr><td>Orzo</td><td>Specchio</td><td><b>DH</b></td></tr> </tbody> </table>		Cassa Structure	Frontali Fronts	Codice Code	Bianco altea	Specchio	<b>QH</b>	Olmo natura	Specchio	<b>BH</b>	Noce biondo	Specchio	<b>RH</b>	Bianco nob.	Specchio	<b>SH</b>	Orzo	Specchio	<b>DH</b>
Cassa Structure	Frontali Fronts	Codice Code																				
Bianco altea	Specchio	<b>QH</b>																				
Olmo natura	Specchio	<b>BH</b>																				
Noce biondo	Specchio	<b>RH</b>																				
Bianco nob.	Specchio	<b>SH</b>																				
Orzo	Specchio	<b>DH</b>																				
Struttura Structure	Frontali Fronts	<b>RFB014</b> _ _																				
<b>NO</b>	<b>SP</b>	<b>369 €</b>																				
<b>LC</b>	<b>SP</b>	<b>394 €</b>																				

CABINE CLOTHES CLOSET UNITS		Cabina con ante specchio Clothes closet unit with mirror door	COMBINAZIONI FINITURE FINISHES COMBINATIONS							
<p>Completare il codice del prodotto con la sigla della <b>finitura</b> scelta. Complete the product code with the chosen finish code.</p> <p><b>Maniglia:</b> pomolo titanio. Handle: titanium finish knob.</p>		 <p>L118,9 - P118,9 - H245</p>	<p><b>Laccato (LC + SP)</b></p> <table border="1"> <thead> <tr> <th>Cassa Structure</th> <th>Frontali Fronts</th> <th>Codice Code</th> </tr> </thead> <tbody> <tr><td>Bianco lucido</td><td>Specchio</td><td><b>EH</b></td></tr> </tbody> </table>		Cassa Structure	Frontali Fronts	Codice Code	Bianco lucido	Specchio	<b>EH</b>
Cassa Structure	Frontali Fronts	Codice Code								
Bianco lucido	Specchio	<b>EH</b>								
Struttura Structure	Frontali Fronts	<b>RFB015</b> _ _								
<b>NO</b>	<b>SP</b>	<b>485 €</b>								
<b>LC</b>	<b>SP</b>	<b>569 €</b>								

TERMINALI END UNITS		Terminale sinistro con anta specchio Left end unit with mirror door	Terminale destro con anta specchio Right end unit with mirror door	COMBINAZIONI FINITURE FINISHES COMBINATIONS							
<p>Completare il codice del prodotto con la sigla della <b>finitura</b> scelta. Complete the product code with the chosen finish code.</p> <p><b>Maniglia:</b> pomolo titanio. Handle: titanium finish knob.</p>		 <p>L41,2 - P55 - H245</p>	 <p>L41,2 - P55 - H245</p>	<p><b>MANIGLIE / HANDLES</b></p> <table border="1"> <thead> <tr> <th>Modello Model</th> <th>Codice Code</th> </tr> </thead> <tbody> <tr><td>Maniglia 1</td><td><b>M1</b></td></tr> <tr><td>Maniglia 2</td><td><b>M2</b></td></tr> </tbody> </table>		Modello Model	Codice Code	Maniglia 1	<b>M1</b>	Maniglia 2	<b>M2</b>
Modello Model	Codice Code										
Maniglia 1	<b>M1</b>										
Maniglia 2	<b>M2</b>										
Struttura Structure	Frontali Fronts	<b>RFB028</b> _ _	<b>RFB027</b> _ _								
<b>NO</b>	<b>SP</b>	<b>259 €</b>	<b>259 €</b>								
<b>LC</b>	<b>SP</b>	<b>281 €</b>	<b>281 €</b>								

# ARMADI SCORREVOLI H245

## SLIDING WARDROBES H245

### ANTE L90 L90 DOORS

Completare il codice del prodotto con la sigla della **finitura** scelta.  
Complete the product code with the chosen finish code.

**Maniglione:** stessa finitura della struttura.\*  
Handles of the same color of the structure.\*

**Armadio 2 ante scorrevoli L90**  
2 L90 sliding doors wardrobe

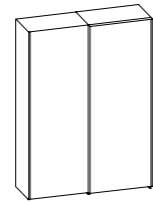

L184,8 - P61 - H245

**Armadio 2 ante scorrevoli L90 con specchio**  
2 L90 sliding doors wardrobe with mirror door

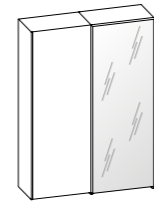

L184,8 - P61 - H245

**Armadio 3 ante scorrevoli L90**  
3 L90 sliding doors wardrobe

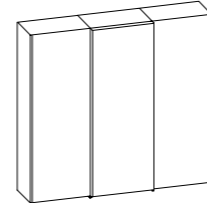

L275,6 - P61 - H245

**Armadio 3 ante scorrevoli L90 con specchio centrale**  
3 L90 sliding doors wardrobe with mirror door

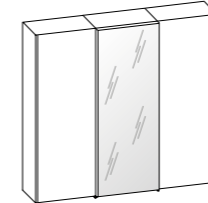

L275,6 - P61 - H245

Struttura Structure	Frontali Fronts
<b>NO</b>	<b>NO</b>
<b>NO</b>	<b>LC</b>
<b>LC</b>	<b>LC</b>

	RFB021 __	RFB022 __	RFB023 __	RFB024 __
<b>631 €</b>	<b>663 €</b>	<b>873 €</b>	<b>978 €</b>	
<b>673 €</b>	<b>705 €</b>	<b>936 €</b>	<b>999 €</b>	
<b>715 €</b>	<b>747 €</b>	<b>999 €</b>	<b>1.052 €</b>	

### ANTE L120-135 L120-135 DOORS

Completare il codice del prodotto con la sigla della **finitura** scelta.  
Complete the product code with the chosen finish code.

**Maniglione:** stessa finitura della struttura.\*  
Handles of the same color of the structure.\*

**Armadio 2 ante PROFILO scorrevoli L120**  
2 L120 PROFILO sliding doors wardrobe

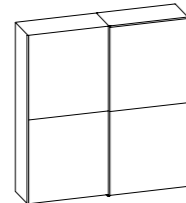

L246 - P61 - H245

**Armadio 2 ante PROFILO scorrevoli L135**  
2 L135 PROFILO sliding doors wardrobe

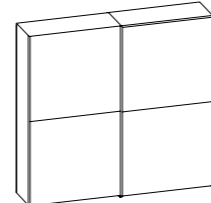

L275,6 - P61 - H245

Struttura Structure	Frontali Fronts
<b>NO</b>	<b>NO</b>
<b>NO</b>	<b>LC</b>
<b>LC</b>	<b>LC</b>

	RFB025 __	RFB026 __
<b>850 €</b>	<b>890 €</b>	
<b>950 €</b>	<b>990 €</b>	
<b>1.002 €</b>	<b>1.042 €</b>	

### COMBINAZIONI FINITURE FINISHES COMBINATIONS

#### Nobilitato (NO + NO)

Cassa Structure	Frontali Fronts	Codice Code
Bianco altea	Bianco altea	<b>QQ</b>
	Bianco nob.	<b>QS</b>
	Orzo	<b>QD</b>
	Argento	<b>QU</b>
Orzo	Oro	<b>QT</b>
	Olmo natura	<b>BB</b>
	Bianco nob.	<b>BS</b>
	Orzo	<b>BD</b>
Olmo natura	Argento	<b>BU</b>
	Oro	<b>BT</b>
	Noce biondo	<b>RR</b>
	Bianco nob.	<b>RS</b>
Noce biondo	Orzo	<b>RD</b>
	Argento	<b>RU</b>
	Oro	<b>RT</b>
	Bianco altea	<b>SQ</b>
Bianco nobilitato	Olmo natura	<b>SB</b>
	Noce biondo	<b>SR</b>
	Bianco nob.	<b>SS</b>
	Orzo	<b>SD</b>
	Argento	<b>SU</b>
	Oro	<b>ST</b>
Orzo	Orzo	<b>DD</b>

#### Nobilitato e laccato (NO + LC)

Cassa Structure	Frontali Fronts	Codice Code
Bianco altea	Bianco lucido	<b>QE</b>
Olmo natura	Bianco lucido	<b>BE</b>
Noce biondo	Bianco lucido	<b>RE</b>



#### Laccato (LC + LC)

Cassa Structure	Frontali Fronts	Codice Code
Bianco lucido	Bianco lucido	<b>EE</b>



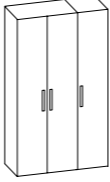
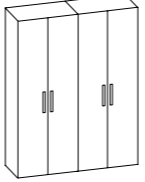

# ARMADI BATTENTI H225

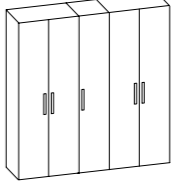
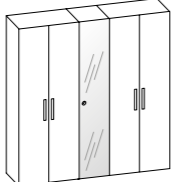
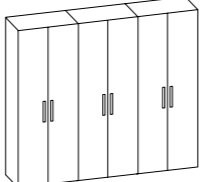
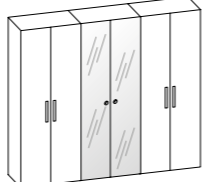
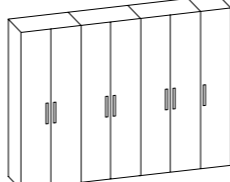
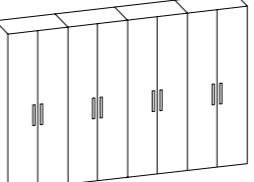
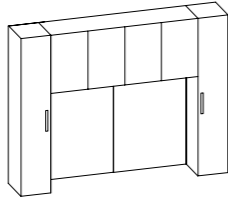
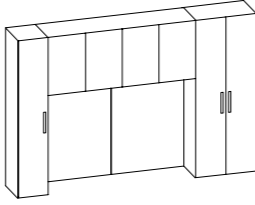
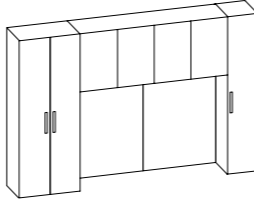
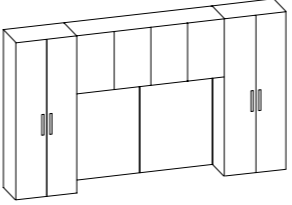
## HINGED WARDROBES H225

ARMADI LINEARI LINEAR WARDROBES		Armadio 1 ante 1 door wardrobe	Armadio 2 ante 2 doors wardrobe	Armadio 3 ante 3 doors wardrobe	Armadio 4 ante 4 doors wardrobe	Armadio 4 ante con 2 ante specchio 4 doors wardrobe with 2 mirror doors	Armadio 5 ante 5 doors wardrobe	COMBINAZIONI FINITURE FINISHES COMBINATIONS																																																												
<p>Completare il codice del prodotto con la sigla della <b>finitura</b> e della <b>maniglia</b> scelta. Complete the product code with the chosen finish and handle code.</p> <p><b>Maniglia:</b> stessa finitura della struttura.* Anta specchio con pomolo titanio. Handles of the same color of the structure.* Mirror door with titanium finish knob.</p>									<b>Nobilitato (NO + NO)</b>																																																											
Struttura Structure	Frontali Fronts	L47,2 - P55 - H224,4 <b>RFB501</b> _ _ _	L92,6 - P55 - H224,4 <b>RFB502</b> _ _ _	L138 - P55 - H224,4 <b>RFB503</b> _ _ _	L183,4 - P55 - H224,4 <b>RFB504</b> _ _ _	L183,4 - P55 - H224,4 <b>RFB509</b> _ _ _	L228,8 - P55 - H224,4 <b>RFB505</b> _ _ _		<table border="1"> <thead> <tr> <th>Cassa Structure</th> <th>Frontali Fronts</th> <th>Codice Code</th> </tr> </thead> <tbody> <tr><td rowspan="4">Bianco altea</td><td>Bianco altea</td><td><b>QQ</b></td></tr> <tr><td>Bianco nob.</td><td><b>QS</b></td></tr> <tr><td>Orzo</td><td><b>QD</b></td></tr> <tr><td>Argento</td><td><b>QU</b></td></tr> <tr><td>Oro</td><td><b>QT</b></td><td></td></tr> <tr><td rowspan="4">Olmo natura</td><td>Olmo natura</td><td><b>BB</b></td></tr> <tr><td>Bianco nob.</td><td><b>BS</b></td></tr> <tr><td>Orzo</td><td><b>BD</b></td></tr> <tr><td>Argento</td><td><b>BU</b></td></tr> <tr><td>Oro</td><td><b>BT</b></td><td></td></tr> <tr><td rowspan="4">Noce biondo</td><td>Noce biondo</td><td><b>RR</b></td></tr> <tr><td>Bianco nob.</td><td><b>RS</b></td></tr> <tr><td>Orzo</td><td><b>RD</b></td></tr> <tr><td>Argento</td><td><b>RU</b></td></tr> <tr><td>Oro</td><td><b>RT</b></td><td></td></tr> <tr><td rowspan="6">Bianco nobilitato</td><td>Bianco altea</td><td><b>SQ</b></td></tr> <tr><td>Olmo natura</td><td><b>SB</b></td></tr> <tr><td>Noce biondo</td><td><b>SR</b></td></tr> <tr><td>Bianco nob.</td><td><b>SS</b></td></tr> <tr><td>Orzo</td><td><b>SD</b></td></tr> <tr><td>Argento</td><td><b>SU</b></td></tr> <tr><td>Oro</td><td><b>ST</b></td><td></td></tr> <tr><td>Orzo</td><td>Orzo</td><td><b>DD</b></td><td></td></tr> </tbody> </table>	Cassa Structure	Frontali Fronts	Codice Code	Bianco altea	Bianco altea	<b>QQ</b>	Bianco nob.	<b>QS</b>	Orzo	<b>QD</b>	Argento	<b>QU</b>	Oro	<b>QT</b>		Olmo natura	Olmo natura	<b>BB</b>	Bianco nob.	<b>BS</b>	Orzo	<b>BD</b>	Argento	<b>BU</b>	Oro	<b>BT</b>		Noce biondo	Noce biondo	<b>RR</b>	Bianco nob.	<b>RS</b>	Orzo	<b>RD</b>	Argento	<b>RU</b>	Oro	<b>RT</b>		Bianco nobilitato	Bianco altea	<b>SQ</b>	Olmo natura	<b>SB</b>	Noce biondo	<b>SR</b>	Bianco nob.	<b>SS</b>	Orzo	<b>SD</b>	Argento	<b>SU</b>	Oro	<b>ST</b>		Orzo	Orzo	<b>DD</b>	
Cassa Structure	Frontali Fronts	Codice Code																																																																		
Bianco altea	Bianco altea	<b>QQ</b>																																																																		
	Bianco nob.	<b>QS</b>																																																																		
	Orzo	<b>QD</b>																																																																		
	Argento	<b>QU</b>																																																																		
Oro	<b>QT</b>																																																																			
Olmo natura	Olmo natura	<b>BB</b>																																																																		
	Bianco nob.	<b>BS</b>																																																																		
	Orzo	<b>BD</b>																																																																		
	Argento	<b>BU</b>																																																																		
Oro	<b>BT</b>																																																																			
Noce biondo	Noce biondo	<b>RR</b>																																																																		
	Bianco nob.	<b>RS</b>																																																																		
	Orzo	<b>RD</b>																																																																		
	Argento	<b>RU</b>																																																																		
Oro	<b>RT</b>																																																																			
Bianco nobilitato	Bianco altea	<b>SQ</b>																																																																		
	Olmo natura	<b>SB</b>																																																																		
	Noce biondo	<b>SR</b>																																																																		
	Bianco nob.	<b>SS</b>																																																																		
	Orzo	<b>SD</b>																																																																		
	Argento	<b>SU</b>																																																																		
Oro	<b>ST</b>																																																																			
Orzo	Orzo	<b>DD</b>																																																																		
<b>NO</b>	<b>NO</b>	<b>175 €</b>	<b>220 €</b>	<b>342 €</b>	<b>379 €</b>	<b>432 €</b>	<b>488 €</b>																																																													
<b>NO</b>	<b>LC</b>	<b>191 €</b>	<b>248 €</b>	<b>387 €</b>	<b>436 €</b>	<b>478 €</b>	<b>552 €</b>																																																													
<b>LC</b>	<b>LC</b>	<b>227 €</b>	<b>284 €</b>	<b>425 €</b>	<b>474 €</b>	<b>526 €</b>	<b>590 €</b>																																																													
ARMADI LINEARI LINEAR WARDROBES		Armadio 5 ante con 1 ante specchio 5 doors wardrobe with 1 mirror door	Armadio 6 ante 6 doors wardrobe	Armadio 6 ante con 2 ante specchio 6 doors wardrobe with 2 mirror doors	Armadio 7 ante 7 doors wardrobe	Armadio 8 ante 8 doors wardrobe		<b>Nobilitato e laccato (NO + LC)</b> <table border="1"> <thead> <tr> <th>Cassa Structure</th> <th>Frontali Fronts</th> <th>Codice Code</th> </tr> </thead> <tbody> <tr><td>Bianco altea</td><td>Bianco lucido</td><td><b>QE</b></td></tr> <tr><td>Olmo natura</td><td>Bianco lucido</td><td><b>BE</b></td></tr> <tr><td>Noce biondo</td><td>Bianco lucido</td><td><b>RE</b></td></tr> </tbody> </table> <b>Laccato (LC + LC)</b> <table border="1"> <thead> <tr> <th>Cassa Structure</th> <th>Frontali Fronts</th> <th>Codice Code</th> </tr> </thead> <tbody> <tr><td>Bianco lucido</td><td>Bianco lucido</td><td><b>EE</b></td></tr> </tbody> </table>	Cassa Structure	Frontali Fronts	Codice Code	Bianco altea	Bianco lucido	<b>QE</b>	Olmo natura	Bianco lucido	<b>BE</b>	Noce biondo	Bianco lucido	<b>RE</b>	Cassa Structure	Frontali Fronts	Codice Code	Bianco lucido	Bianco lucido	<b>EE</b>																																										
Cassa Structure	Frontali Fronts	Codice Code																																																																		
Bianco altea	Bianco lucido	<b>QE</b>																																																																		
Olmo natura	Bianco lucido	<b>BE</b>																																																																		
Noce biondo	Bianco lucido	<b>RE</b>																																																																		
Cassa Structure	Frontali Fronts	Codice Code																																																																		
Bianco lucido	Bianco lucido	<b>EE</b>																																																																		
<p>Completare il codice del prodotto con la sigla della <b>finitura</b> e della <b>maniglia</b> scelta. Complete the product code with the chosen finish and handle code.</p> <p><b>Maniglia:</b> stessa finitura della struttura.* Anta specchio con pomolo titanio. Handles of the same color of the structure.* Mirror door with titanium finish knob.</p>																																																																				
Struttura Structure	Frontali Fronts	L228,8 - P55 - H224,4 <b>RFB510</b> _ _ _	L274,2 - P55 - H224,4 <b>RFB506</b> _ _ _	L274,2 - P55 - H224,4 <b>RFB511</b> _ _ _	L319,6 - P55 - H224,4 <b>RFB507</b> _ _ _	L365 - P55 - H224,4 <b>RFB508</b> _ _ _																																																														
<b>NO</b>	<b>NO</b>	<b>514 €</b>	<b>522 €</b>	<b>597 €</b>	<b>717 €</b>	<b>765 €</b>																																																														
<b>NO</b>	<b>LC</b>	<b>578 €</b>	<b>607 €</b>	<b>635 €</b>	<b>822 €</b>	<b>882 €</b>																																																														
<b>LC</b>	<b>LC</b>	<b>616 €</b>	<b>635 €</b>	<b>664 €</b>	<b>859 €</b>	<b>919 €</b>																																																														
PONTI BRIDGE UNITS		Ponte con 2 vani da 45 Bridge unit with 2 L45 units	Ponte con un vano da 45 e uno da 90 Bridge unit with L45 and L90 units	Ponte con un vano da 45 e uno da 90 Bridge unit with L45 and L90 units	Ponte con 2 vani da 90 Bridge unit with 2 L90 units			<b>MANIGLIE / HANDLES</b> <table border="1"> <thead> <tr> <th>Modello Model</th> <th>Codice Code</th> </tr> </thead> <tbody> <tr><td>Maniglia 1</td><td><b>M1</b></td></tr> <tr><td>Maniglia 2</td><td><b>M2</b></td></tr> </tbody> </table>	Modello Model	Codice Code	Maniglia 1	<b>M1</b>	Maniglia 2	<b>M2</b>																																																						
Modello Model	Codice Code																																																																			
Maniglia 1	<b>M1</b>																																																																			
Maniglia 2	<b>M2</b>																																																																			
<p>Completare il codice del prodotto con la sigla della <b>finitura</b> e della <b>maniglia</b> scelta. Complete the product code with the chosen finish and handle code.</p> <p><b>Maniglia:</b> stessa finitura della struttura.* Handles of the same color of the structure.*</p>																																																																				
Struttura Structure	Frontali Fronts	L319,6 - P55 - H224,4 <b>RFB518</b> _ _ _	L365 - P55 - H224,4 <b>RFB519</b> _ _ _	L365 - P55 - H224,4 <b>RFB520</b> _ _ _	L410,4 - P55 - H224,4 <b>RFB529</b> _ _ _																																																															
<b>NO</b>	<b>NO</b>	<b>758 €</b>	<b>834 €</b>	<b>834 €</b>	<b>879 €</b>																																																															
<b>NO</b>	<b>LC</b>	<b>815 €</b>	<b>910 €</b>	<b>910 €</b>	<b>967 €</b>																																																															
<b>LC</b>	<b>LC</b>	-	-	-	-																																																															



## ARMADI BATTENTI SPECIALI H225

### SPECIAL HINGED WARDROBES H225

ANGOLI CORNER UNITS		Angolo Corner unit		COMBINAZIONI FINITURE FINISHES COMBINATIONS																																																								
<p>Completare il codice del prodotto con la sigla della <b>finitura</b> e della <b>maniglia</b> scelta. Complete the product code with the chosen finish and handle code.</p> <p><b>Maniglia:</b> stessa finitura della struttura.* Handles of the same color of the structure.*</p>		 <p>L86,2 - P86,2 - H224,4</p>		<p><b>Nobilitato (NO + NO)</b></p> <table border="1"> <thead> <tr> <th>Cassa Structure</th> <th>Frontali Fronts</th> <th>Codice Code</th> </tr> </thead> <tbody> <tr><td rowspan="5">Bianco altea</td><td>Bianco altea</td><td><b>QQ</b></td></tr> <tr><td>Bianco nob.</td><td><b>QS</b></td></tr> <tr><td>Orzo</td><td><b>QD</b></td></tr> <tr><td>Argento</td><td><b>QU</b></td></tr> <tr><td>Oro</td><td><b>QT</b></td></tr> <tr><td rowspan="5">Olmo natura</td><td>Olmo natura</td><td><b>BB</b></td></tr> <tr><td>Bianco nob.</td><td><b>BS</b></td></tr> <tr><td>Orzo</td><td><b>BD</b></td></tr> <tr><td>Argento</td><td><b>BU</b></td></tr> <tr><td>Oro</td><td><b>BT</b></td></tr> <tr><td rowspan="5">Noce biondo</td><td>Noce biondo</td><td><b>RR</b></td></tr> <tr><td>Bianco nob.</td><td><b>RS</b></td></tr> <tr><td>Orzo</td><td><b>RD</b></td></tr> <tr><td>Argento</td><td><b>RU</b></td></tr> <tr><td>Oro</td><td><b>RT</b></td></tr> <tr><td rowspan="5">Bianco nob.</td><td>Bianco altea</td><td><b>SQ</b></td></tr> <tr><td>Olmo natura</td><td><b>SB</b></td></tr> <tr><td>Noce biondo</td><td><b>SR</b></td></tr> <tr><td>Bianco nob.</td><td><b>SS</b></td></tr> <tr><td>Orzo</td><td><b>SD</b></td></tr> <tr><td rowspan="3">Orzo</td><td>Argento</td><td><b>SU</b></td></tr> <tr><td>Oro</td><td><b>ST</b></td></tr> <tr><td>Orzo</td><td><b>DD</b></td></tr> </tbody> </table>			Cassa Structure	Frontali Fronts	Codice Code	Bianco altea	Bianco altea	<b>QQ</b>	Bianco nob.	<b>QS</b>	Orzo	<b>QD</b>	Argento	<b>QU</b>	Oro	<b>QT</b>	Olmo natura	Olmo natura	<b>BB</b>	Bianco nob.	<b>BS</b>	Orzo	<b>BD</b>	Argento	<b>BU</b>	Oro	<b>BT</b>	Noce biondo	Noce biondo	<b>RR</b>	Bianco nob.	<b>RS</b>	Orzo	<b>RD</b>	Argento	<b>RU</b>	Oro	<b>RT</b>	Bianco nob.	Bianco altea	<b>SQ</b>	Olmo natura	<b>SB</b>	Noce biondo	<b>SR</b>	Bianco nob.	<b>SS</b>	Orzo	<b>SD</b>	Orzo	Argento	<b>SU</b>	Oro	<b>ST</b>	Orzo	<b>DD</b>
Cassa Structure	Frontali Fronts	Codice Code																																																										
Bianco altea	Bianco altea	<b>QQ</b>																																																										
	Bianco nob.	<b>QS</b>																																																										
	Orzo	<b>QD</b>																																																										
	Argento	<b>QU</b>																																																										
	Oro	<b>QT</b>																																																										
Olmo natura	Olmo natura	<b>BB</b>																																																										
	Bianco nob.	<b>BS</b>																																																										
	Orzo	<b>BD</b>																																																										
	Argento	<b>BU</b>																																																										
	Oro	<b>BT</b>																																																										
Noce biondo	Noce biondo	<b>RR</b>																																																										
	Bianco nob.	<b>RS</b>																																																										
	Orzo	<b>RD</b>																																																										
	Argento	<b>RU</b>																																																										
	Oro	<b>RT</b>																																																										
Bianco nob.	Bianco altea	<b>SQ</b>																																																										
	Olmo natura	<b>SB</b>																																																										
	Noce biondo	<b>SR</b>																																																										
	Bianco nob.	<b>SS</b>																																																										
	Orzo	<b>SD</b>																																																										
Orzo	Argento	<b>SU</b>																																																										
	Oro	<b>ST</b>																																																										
	Orzo	<b>DD</b>																																																										
<p>Struttura Structure</p> <p>Frontali Fronts</p>		<p>RFB512 _ _ _ _</p>		<p><b>Nobilitato e laccato (NO + LC)</b></p> <table border="1"> <thead> <tr> <th>Cassa Structure</th> <th>Frontali Fronts</th> <th>Codice Code</th> </tr> </thead> <tbody> <tr><td>Bianco altea</td><td>Bianco lucido</td><td><b>QE</b></td></tr> <tr><td>Olmo natura</td><td>Bianco lucido</td><td><b>BE</b></td></tr> <tr><td>Noce biondo</td><td>Bianco lucido</td><td><b>RE</b></td></tr> </tbody> </table>			Cassa Structure	Frontali Fronts	Codice Code	Bianco altea	Bianco lucido	<b>QE</b>	Olmo natura	Bianco lucido	<b>BE</b>	Noce biondo	Bianco lucido	<b>RE</b>																																										
Cassa Structure	Frontali Fronts	Codice Code																																																										
Bianco altea	Bianco lucido	<b>QE</b>																																																										
Olmo natura	Bianco lucido	<b>BE</b>																																																										
Noce biondo	Bianco lucido	<b>RE</b>																																																										
<p><b>NO NO</b> 313 €</p> <p><b>NO LC</b> 329 €</p> <p><b>LC LC</b> 351 €</p>				<p><b>Laccato (LC + LC)</b></p> <table border="1"> <thead> <tr> <th>Cassa Structure</th> <th>Frontali Fronts</th> <th>Codice Code</th> </tr> </thead> <tbody> <tr><td>Bianco lucido</td><td>Bianco lucido</td><td><b>EE</b></td></tr> </tbody> </table>			Cassa Structure	Frontali Fronts	Codice Code	Bianco lucido	Bianco lucido	<b>EE</b>																																																
Cassa Structure	Frontali Fronts	Codice Code																																																										
Bianco lucido	Bianco lucido	<b>EE</b>																																																										
<p>Struttura Structure</p> <p>Frontali Fronts</p>		<p>RFB517 _ _ _ _</p>		<p><b>MANIGLIE / HANDLES</b></p> <table border="1"> <thead> <tr> <th>Modello Model</th> <th>Codice Code</th> </tr> </thead> <tbody> <tr><td>Maniglia 1</td><td><b>M1</b></td></tr> <tr><td>Maniglia 2</td><td><b>M2</b></td></tr> </tbody> </table>			Modello Model	Codice Code	Maniglia 1	<b>M1</b>	Maniglia 2	<b>M2</b>																																																
Modello Model	Codice Code																																																											
Maniglia 1	<b>M1</b>																																																											
Maniglia 2	<b>M2</b>																																																											
<p><b>NO NO</b> 218 €</p> <p><b>NO LC</b> 229 €</p> <p><b>LC LC</b> 251 €</p>		<p>RFB516 _ _ _ _</p>																																																										
<p>Struttura Structure</p> <p>Frontali Fronts</p>		<p>Terminale sinistro Left end unit</p>  <p>L41,2 - P55 - H224,4</p>		<p>Terminale destro Right end unit</p>  <p>L41,2 - P55 - H224,4</p>																																																								
<p><b>NO NO</b> 218 €</p> <p><b>NO LC</b> 229 €</p> <p><b>LC LC</b> 251 €</p>																																																												

## ARMADI BATTENTI SPECIALI CON ANTA SPECCHIO H225

### SPECIAL HINGED WARDROBES WITH MIRROR DOORS H225

ANGOLI CORNER UNITS		Angolo con anta specchio Corner unit with mirror door		COMBINAZIONI FINITURE FINISHES COMBINATIONS																				
<p>Completare il codice del prodotto con la sigla della <b>finitura</b> scelta. Complete the product code with the chosen finish code.</p> <p><b>Maniglia:</b> pomolo titanio. Handle: titanium finish knob.</p>		 <p>L86,2 - P86,2 - H224,4</p>		<p><b>Nobilitato (NO + NO)</b></p> <table border="1"> <thead> <tr> <th>Cassa Structure</th> <th>Frontali Fronts</th> <th>Codice Code</th> </tr> </thead> <tbody> <tr><td>Bianco altea</td><td>Specchio</td><td><b>QH</b></td></tr> <tr><td>Olmo natura</td><td>Specchio</td><td><b>BH</b></td></tr> <tr><td>Noce biondo</td><td>Specchio</td><td><b>RH</b></td></tr> <tr><td>Bianco nob.</td><td>Specchio</td><td><b>SH</b></td></tr> <tr><td>Orzo</td><td>Specchio</td><td><b>DH</b></td></tr> </tbody> </table>			Cassa Structure	Frontali Fronts	Codice Code	Bianco altea	Specchio	<b>QH</b>	Olmo natura	Specchio	<b>BH</b>	Noce biondo	Specchio	<b>RH</b>	Bianco nob.	Specchio	<b>SH</b>	Orzo	Specchio	<b>DH</b>
Cassa Structure	Frontali Fronts	Codice Code																						
Bianco altea	Specchio	<b>QH</b>																						
Olmo natura	Specchio	<b>BH</b>																						
Noce biondo	Specchio	<b>RH</b>																						
Bianco nob.	Specchio	<b>SH</b>																						
Orzo	Specchio	<b>DH</b>																						
<p>Struttura Structure</p> <p>Frontali Fronts</p>		<p>RFB514 _ _</p>		<p><b>Laccato (LC + SP)</b></p> <table border="1"> <thead> <tr> <th>Cassa Structure</th> <th>Frontali Fronts</th> <th>Codice Code</th> </tr> </thead> <tbody> <tr><td>Bianco lucido</td><td>Specchio</td><td><b>EH</b></td></tr> </tbody> </table>			Cassa Structure	Frontali Fronts	Codice Code	Bianco lucido	Specchio	<b>EH</b>												
Cassa Structure	Frontali Fronts	Codice Code																						
Bianco lucido	Specchio	<b>EH</b>																						
<p><b>NO SP</b> 369 €</p> <p><b>LC SP</b> 394 €</p>																								
<p>Struttura Structure</p> <p>Frontali Fronts</p>		<p>RFB528 _ _</p>		<p>RFB527 _ _</p>																				
<p><b>NO SP</b> 259 €</p> <p><b>LC SP</b> 281 €</p>		<p>RFB527 _ _</p>																						
<p>Struttura Structure</p> <p>Frontali Fronts</p>		<p>Terminale sinistro con anta specchio Left end unit with mirror door</p>  <p>L41,2 - P55 - H224,4</p>		<p>Terminale destro con anta specchio Right end unit with mirror door</p>  <p>L41,2 - P55 - H224,4</p>																				
<p><b>NO SP</b> 259 €</p> <p><b>LC SP</b> 281 €</p>																								

# ARMADI SCORREVOLI H225

## SLIDING WARDROBES H225

### ANTE L90 L90 DOORS

Completare il codice del prodotto con la sigla della **finitura** scelta.  
Complete the product code with the chosen finish code.

**Maniglione:** stessa finitura della struttura.\*  
Handles of the same color of the structure.\*

**Armadio 2 ante scorrevoli L90**  
2 L90 sliding doors wardrobe

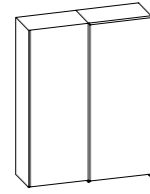

L184,8 - P61 - H224,4

**Armadio 2 ante scorrevoli L90 con specchio**  
2 L90 sliding doors wardrobe with mirror door

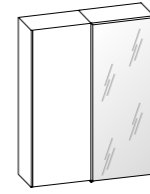

L184,8 - P61 - H224,4

**Armadio 3 ante scorrevoli L90**  
3 L90 sliding doors wardrobe

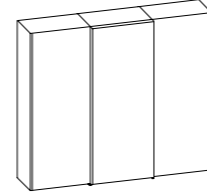

L275,6 - P61 - H224,4

**Armadio 3 ante scorrevoli L90 con specchio centrale**  
3 L90 sliding doors wardrobe with mirror door

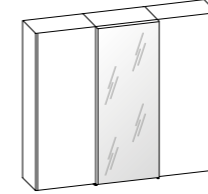

L275,6 - P61 - H224,4

Struttura Structure	Frontali Fronts	RFB521 __	RFB522 __	RFB523 __	RFB524 __
<b>NO</b>	<b>NO</b>	<b>631 €</b>	<b>663 €</b>	<b>873 €</b>	<b>978 €</b>
<b>NO</b>	<b>LC</b>	<b>673 €</b>	<b>705 €</b>	<b>936 €</b>	<b>999 €</b>
<b>LC</b>	<b>LC</b>	<b>715 €</b>	<b>747 €</b>	<b>999 €</b>	<b>1.052 €</b>

### ANTE L120-135 L120-135 DOORS

Completare il codice del prodotto con la sigla della **finitura** scelta.  
Complete the product code with the chosen finish code.

**Maniglione:** stessa finitura della struttura.\*  
Handles of the same color of the structure.\*

**Armadio 2 ante PROFILO scorrevoli L120**  
2 L120 PROFILO sliding doors wardrobe

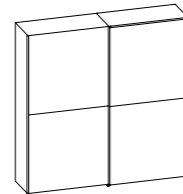

L246 - P61 - H224,4

**Armadio 2 ante PROFILO scorrevoli L135**  
2 L135 PROFILO sliding doors wardrobe

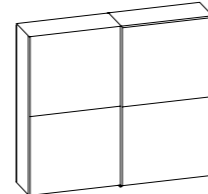

L275,6 - P61 - H224,4

Struttura Structure	Frontali Fronts	RFB525 __	RFB526 __
<b>NO</b>	<b>NO</b>	<b>850 €</b>	<b>890 €</b>
<b>NO</b>	<b>LC</b>	<b>950 €</b>	<b>990 €</b>
<b>LC</b>	<b>LC</b>	<b>1.002 €</b>	<b>1.042 €</b>

### COMBINAZIONI FINITURE FINISHES COMBINATIONS

#### Nobilitato (NO + NO)

Cassa Structure	Frontali Fronts	Codice Code
Bianco altea	Bianco altea	<b>QQ</b>
	Bianco nob.	<b>QS</b>
	Orzo	<b>QD</b>
	Argento	<b>QU</b>
Orzo	Oro	<b>QT</b>
	Olmo natura	<b>BB</b>
	Bianco nob.	<b>BS</b>
	Orzo	<b>BD</b>
Olmo natura	Argento	<b>BU</b>
	Oro	<b>BT</b>
	Noce biondo	<b>RR</b>
	Bianco nob.	<b>RS</b>
Noce biondo	Orzo	<b>RD</b>
	Argento	<b>RU</b>
	Oro	<b>RT</b>
	Bianco altea	<b>SQ</b>
Bianco nobilitato	Olmo natura	<b>SB</b>
	Noce biondo	<b>SR</b>
	Bianco nob.	<b>SS</b>
	Orzo	<b>SD</b>
	Argento	<b>SU</b>
	Oro	<b>ST</b>
Orzo	Orzo	<b>DD</b>

#### Nobilitato e laccato (NO + LC)

Cassa Structure	Frontali Fronts	Codice Code
Bianco altea	Bianco lucido	<b>QE</b>
Olmo natura	Bianco lucido	<b>BE</b>
Noce biondo	Bianco lucido	<b>RE</b>

#### Laccato (LC + LC)

Cassa Structure	Frontali Fronts	Codice Code
Bianco lucido	Bianco lucido	<b>EE</b>

# COMPLEMENTI PER ARMADI



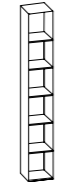
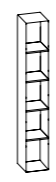
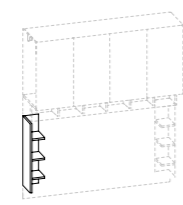
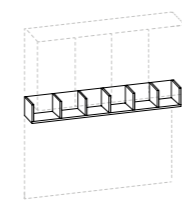
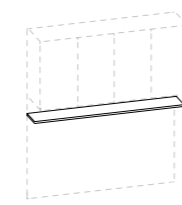
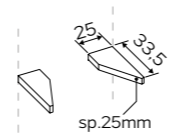



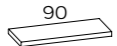
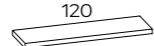
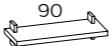
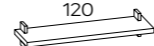

## COMPLEMENTS FOR WARDROBES



LIBRERIA BOOKCASE	Libreria L35 H245 Bookcase L35 H245	Libreria L35 H225 Bookcase L35 H225					COMBINAZIONI FINITURE FINISHES COMBINATIONS																
	L35 - P35 - H245	L35 - P35 - H224,4																					
<p>Completare il codice del prodotto con la sigla della <b>finitura</b> scelta. Complete the product code with the chosen finish code.</p>							<p><b>Nobilitato (NO)</b></p> <table border="1"> <thead> <tr> <th>Finitura Finish</th> <th>Codice Code</th> </tr> </thead> <tbody> <tr> <td>Bianco altea</td> <td><b>Q</b></td> </tr> <tr> <td>Olmo natura</td> <td><b>B</b></td> </tr> <tr> <td>Noce biondo</td> <td><b>R</b></td> </tr> <tr> <td>Bianco nobilitato</td> <td><b>S</b></td> </tr> <tr> <td>Orzo</td> <td><b>D</b></td> </tr> <tr> <td>Metallo argento</td> <td><b>U</b></td> </tr> <tr> <td>Metallo oro</td> <td><b>T</b></td> </tr> </tbody> </table>	Finitura Finish	Codice Code	Bianco altea	<b>Q</b>	Olmo natura	<b>B</b>	Noce biondo	<b>R</b>	Bianco nobilitato	<b>S</b>	Orzo	<b>D</b>	Metallo argento	<b>U</b>	Metallo oro	<b>T</b>
Finitura Finish	Codice Code																						
Bianco altea	<b>Q</b>																						
Olmo natura	<b>B</b>																						
Noce biondo	<b>R</b>																						
Bianco nobilitato	<b>S</b>																						
Orzo	<b>D</b>																						
Metallo argento	<b>U</b>																						
Metallo oro	<b>T</b>																						
Finitura Finish	<b>AFB001_</b>	<b>AFB002_</b>																					
<b>NO</b>	<b>218 €</b>	<b>201 €</b>																					
ACCESSORI PER PONTE ACCESSORIES FOR BRIDGE UNIT	Libreria ponte verticale Vertical bookcase for bridge unit	Libreria ponte orizzontale Horizontal bookcase for bridge unit	Mensola sottoponte Shelf for bridge unit	Coppia mensole sagomate N.2 shaped shelves																			
<p>Completare il codice del prodotto con la sigla della <b>finitura</b> scelta. Complete the product code with the chosen finish code.</p>																							
Finitura Finish	L27 - P27 - H112 <b>AFB003_</b>	L225 - P27 - H27 <b>AFB004_</b>	L225 - P26 - H2,5 <b>AFB005_</b>	<b>AFB056_</b>																			
<b>NO</b>	<b>101 €</b>	<b>122 €</b>	<b>49 €</b>	<b>48 €</b>																			

## COMPLEMENTI PER ARMADI

### COMPLEMENTS FOR WARDROBES

MENSOLE SHELVES	Mensola L90 reggimensola interni L90 shelf with internal supports	Mensola L120 reggimensola interni L120 shelf with internal supports	Mensola L90 reggimensola esterni Kalabrone L90 shelf with Kalabrone external supports	Mensola L120 reggimensola esterni Kalabrone L120 shelf with Kalabrone external supports					COMBINAZIONI FINITURE FINISHES COMBINATIONS																
																									
Completare il codice del prodotto con la sigla della <b>finitura</b> scelta. Complete the product code with the chosen finish code.	L90 - P26 - H2,5	L120 - P26 - H2,5	L90 - P26 - H2,5	L120 - P26 - H2,5					<b>Nobilitato (NO)</b>																
Finitura Finish	<b>AFB050 _</b>	<b>AFB051 _</b>	<b>AFB052 _</b>	<b>AFB053 _</b>					<table border="1"> <thead> <tr> <th>Finitura Finish</th> <th>Codice Code</th> </tr> </thead> <tbody> <tr> <td>Bianco altea</td> <td><b>Q</b></td> </tr> <tr> <td>Olmo natura</td> <td><b>B</b></td> </tr> <tr> <td>Noce biondo</td> <td><b>R</b></td> </tr> <tr> <td>Bianco nobilitato</td> <td><b>S</b></td> </tr> <tr> <td>Orzo</td> <td><b>D</b></td> </tr> <tr> <td>Metallo argento</td> <td><b>U</b></td> </tr> <tr> <td>Metallo oro</td> <td><b>T</b></td> </tr> </tbody> </table>	Finitura Finish	Codice Code	Bianco altea	<b>Q</b>	Olmo natura	<b>B</b>	Noce biondo	<b>R</b>	Bianco nobilitato	<b>S</b>	Orzo	<b>D</b>	Metallo argento	<b>U</b>	Metallo oro	<b>T</b>
Finitura Finish	Codice Code																								
Bianco altea	<b>Q</b>																								
Olmo natura	<b>B</b>																								
Noce biondo	<b>R</b>																								
Bianco nobilitato	<b>S</b>																								
Orzo	<b>D</b>																								
Metallo argento	<b>U</b>																								
Metallo oro	<b>T</b>																								
<b>NO</b>	<b>44 €</b>	<b>49 €</b>	<b>80 €</b>	<b>85 €</b>																					

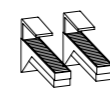
BOISERIE CON PORTAVALIGIA BOISERIE WITH LUGGAGE RACK	Boiserie H245 L60 con portavaligia Boiserie H245 L60 with luggage rack	Boiserie H245 L90 con portavaligia, con 2 appendiabiti colore titanio inclusi Boiserie H245 L90 with luggage rack, with 2 titanium coloured coat hangers	Boiserie H225 L60 con portavaligia Boiserie H225 L60 with luggage rack	Boiserie H225 L90 con portavaligia, con 2 appendiabiti colore titanio inclusi Boiserie H225 L90 with luggage rack, with 2 titanium coloured coat hangers	Portavaligia L60 L60 luggage rack	Portavaligia L90 L90 luggage rack	Mensola L60 per boiserie L60 shelf for boiserie	Mensola L90 per boiserie L90 shelf for boiserie	COMBINAZIONI FINITURE FINISHES COMBINATIONS								
																	
Completare il codice del prodotto con la sigla della <b>finitura</b> scelta. Complete the product code with the chosen finish code.	L60 - P51 - H245	L90 - P51 - H245	L60 - P51 - H224,4	L90 - P51 - H224,4	L60 - P47,9 - H50	L90 - P47,9 - H50	L60 - P26 - H2,5	L90 - P26 - H2,5	<b>Nobilitato (NO)</b>								
Finitura Finish	<b>AFB041 _</b>	<b>AFB042 _</b>	<b>AFB043 _</b>	<b>AFB044 _</b>	<b>AFB060 _</b>	<b>AFB061 _</b>	<b>AFB054 _</b>	<b>AFB055 _</b>	<table border="1"> <thead> <tr> <th>Finitura Finish</th> <th>Codice Code</th> </tr> </thead> <tbody> <tr> <td>Bianco altea</td> <td><b>Q</b></td> </tr> <tr> <td>Olmo natura</td> <td><b>B</b></td> </tr> <tr> <td>Noce biondo</td> <td><b>R</b></td> </tr> </tbody> </table>	Finitura Finish	Codice Code	Bianco altea	<b>Q</b>	Olmo natura	<b>B</b>	Noce biondo	<b>R</b>
Finitura Finish	Codice Code																
Bianco altea	<b>Q</b>																
Olmo natura	<b>B</b>																
Noce biondo	<b>R</b>																
<b>NO</b>	<b>267 €</b>	<b>335 €</b>	<b>267 €</b>	<b>335 €</b>	<b>84 €</b>	<b>100 €</b>	<b>39 €</b>	<b>45 €</b>									

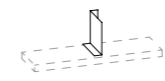
REGGIMENSOLE SUPPORTS	Coppia reggimensola a scomparsa per mensola Internal supports for shelf	Coppia reggimensole esterne Kalabrone per mensola External supports Kalabrone for shelf	Coppia reggimensole per boiserie Supports for boiserie shelves	Completare il codice del prodotto con la sigla della <b>finitura</b> scelta. Complete the product code with the chosen finish code.	Fermalibro per mensole Support for shelves			COMBINAZIONI FINITURE FINISHES COMBINATIONS										
																		
	<b>AFB064</b>	<b>AFB065</b>	<b>AFB066</b>	Finitura Finish	<b>AFB057 _</b>			<b>Nobilitato (NO)</b>										
Prezzo / Price	<b>18 €</b>	<b>50 €</b>	<b>16 €</b>	<b>NO</b>	<b>34 €</b>			<table border="1"> <thead> <tr> <th>Finitura Finish</th> <th>Codice Code</th> </tr> </thead> <tbody> <tr> <td>Bianco nobilitato</td> <td><b>S</b></td> </tr> <tr> <td>Orzo</td> <td><b>D</b></td> </tr> <tr> <td>Metallo argento</td> <td><b>U</b></td> </tr> <tr> <td>Metallo oro</td> <td><b>T</b></td> </tr> </tbody> </table>	Finitura Finish	Codice Code	Bianco nobilitato	<b>S</b>	Orzo	<b>D</b>	Metallo argento	<b>U</b>	Metallo oro	<b>T</b>
Finitura Finish	Codice Code																	
Bianco nobilitato	<b>S</b>																	
Orzo	<b>D</b>																	
Metallo argento	<b>U</b>																	
Metallo oro	<b>T</b>																	

# GRUPPI BEDROOM SETS

Nota bene: tutti i gruppi sono dotati di guide a rotella  
Note: the bedroom sets are equipped with standard rail

Nota bene: tutti i gruppi sono dotati di guide a rotella  
Note: the bedroom sets are equipped with standard rail

## CADY

Completare il codice del prodotto con la sigla della **finitura** e della **maniglia** scelta.  
Complete the product code with the chosen finish and handle code.

**Maniglia:** stessa finitura della struttura, nella versione Bianco (nobilitato), la maniglia è finitura laccato Bianco lucido.  
Handles of the same color of the structure. In Bianco (melamine) version, the handle is in lacquered Bianco lucido version.

Consegnato montato.  
Delivered assembled.

Disponibile kit ammortizzatore per guide optional.  
Optional soft closing available.

### Comodino CADY 2 cassetti

Night stand CADY with 2 drawers



L53,8 - P39,1 - H43,1

### Comò CADY 3 cassetti

Dresser CADY with 3 drawers

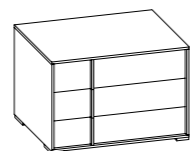

L114,2 - P45,1 - H76,9

### COMBINAZIONI FINITURE FINISHES COMBINATIONS

#### Nobilitato (NO + NO)

Cassa Structure	Frontali Fronts	Codice Code
Bianco altea	Orzo	<b>QD</b>
	Argento	<b>QU</b>
	Oro	<b>QT</b>
Olmo natura	Orzo	<b>BD</b>
	Argento	<b>BU</b>
	Oro	<b>BT</b>
Noce biondo	Orzo	<b>RD</b>
	Argento	<b>RU</b>
	Oro	<b>RT</b>

#### Nobilitato e laccato (NO + LC)

Bianco altea	Bianco lucido	<b>QE</b>
Olmo natura	Bianco lucido	<b>BE</b>
Noce biondo	Bianco lucido	<b>RE</b>

#### MANIGLIE / HANDLES

Modello / Model	Cod.
Maniglia M1	<b>M1</b>
Maniglia M2	<b>M2</b>

Struttura Structure	Frontali Fronts	TFB001 _ _ _	TFB002 _ _ _
<b>NO</b>	<b>NO</b>	<b>99 €</b>	<b>199 €</b>
<b>NO</b>	<b>LC</b>	<b>109 €</b>	<b>219 €</b>
<b>LC</b>	<b>LC</b>	-	-

## AUX

Completare il codice del prodotto con la sigla della **finitura** scelta.  
Complete the product code with the chosen finish code.

Consegnato montato.  
Delivered assembled.

**Non ammortizzabile.**  
Soft closing not available.

### Comodino AUX 2 cassetti

Night stand AUX with 2 drawers



L54,7 - P44,6 - H40,5

### Comò AUX 3 cassetti

Dresser AUX with 3 drawers

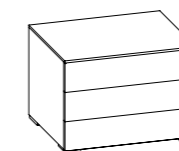

L108,7 - P44,6 - H77,1

### Settimino AUX 6 cassetti

6 drawers unit AUX

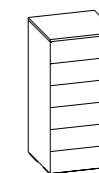

L54,7 - P44,6 - H113,5

### COMBINAZIONI FINITURE FINISHES COMBINATIONS

#### Nobilitato (NO + NO)

Cassa Structure	Frontali Fronts	Codice Code
Bianco altea	Bianco altea	<b>QQ</b>
Olmo natura	Olmo natura	<b>BB</b>
Noce biondo	Noce biondo	<b>RR</b>
Orzo	Orzo	<b>DD</b>
Argento	Argento	<b>UU</b>
Oro	Oro	<b>TT</b>
Bianco nob.	Bianco nob.	<b>SS</b>

#### Laccato (LC + LC)

Bianco lucido	Bianco lucido	<b>EE</b>
---------------	---------------	-----------

Struttura Structure	Frontali Fronts	TFB006 _ _	TFB007 _ _	TFB008 _ _
<b>NO</b>	<b>NO</b>	<b>105 €</b>	<b>178 €</b>	<b>225 €</b>
<b>NO</b>	<b>LC</b>	-	-	-
<b>LC</b>	<b>LC</b>	<b>121 €</b>	<b>221 €</b>	<b>265 €</b>

## SMALL

Completare il codice del prodotto con la sigla della **finitura** e della **maniglia** scelta.  
Complete the product code with the chosen finish and handle code.

**Maniglia:** stessa finitura della struttura, nella versione Bianco (nobilitato), la maniglia è finitura laccato Bianco lucido.  
Handles of the same color of the structure. In Bianco (melamine) version, the handle is in lacquered Bianco lucido version.

Consegnato montato.  
Delivered assembled.

Disponibile kit ammortizzatore per guide optional.  
Optional soft closing available.

### Comodino SMALL 2 cassetti

Night stand SMALL with 2 drawers



L55,6 - P42 - H42,2

### Comò SMALL 3 cassetti

Dresser SMALL with 3 drawers



L116 - P48 - H76

#### Nobilitato (NO + NO)

Cassa Structure	Frontali Fronts	Codice Code
Bianco altea	Bianco altea	<b>QQ</b>
	Orzo	<b>QD</b>
	Argento	<b>QU</b>
	Oro	<b>QT</b>
Olmo natura	Olmo natura	<b>BB</b>
	Orzo	<b>BD</b>
	Argento	<b>BU</b>
	Oro	<b>BT</b>
Noce biondo	Noce biondo	<b>RR</b>
	Orzo	<b>RD</b>
	Argento	<b>RU</b>
	Oro	<b>RT</b>
Orzo	Orzo	<b>DD</b>

#### Nobilitato e laccato (NO + LC)

Bianco altea	Bianco lucido	<b>QE</b>
Olmo natura	Bianco lucido	<b>BE</b>
Noce biondo	Bianco lucido	<b>RE</b>

#### Laccato (LC + LC)

Bianco lucido	Bianco lucido	<b>EE</b>
---------------	---------------	-----------

#### MANIGLIE / HANDLES

Modello / Model	Cod.
Maniglia M1	<b>M1</b>
Maniglia M2	<b>M2</b>

Struttura Structure	Frontali Fronts	TFB003 _ _ _	TFB004 _ _ _
<b>NO</b>	<b>NO</b>	<b>87 €</b>	<b>181 €</b>
<b>NO</b>	<b>LC</b>	<b>91 €</b>	<b>191 €</b>
<b>LC</b>	<b>LC</b>	<b>99 €</b>	<b>209 €</b>

## LUX

Completare il codice del prodotto con la sigla della **finitura** e della **maniglia** scelta.  
Complete the product code with the chosen finish and handle code.

**Maniglia:** stessa finitura della struttura, nella versione Bianco (nobilitato), la maniglia è finitura laccato Bianco lucido.  
Handles of the same color of the structure. In Bianco (melamine) version, the handle is in lacquered Bianco lucido version.

Consegnato montato.  
Delivered assembled.

**Non ammortizzabile.**  
Soft closing not available.

### Comodino LUX 2 cassetti

Night stand LUX with 2 drawers



L53 - P44,6 - H43,2

### Comò LUX 3 cassetti

Dresser LUX with 3 drawers



L107 - P44,6 - H79,8

#### Nobilitato (NO + NO)

Cassa Structure	Frontali Fronts	Codice Code
Bianco altea	Bianco altea	<b>QQ</b>
Olmo natura	Olmo natura	<b>BB</b>
Noce biondo	Noce biondo	<b>RR</b>
Orzo	Orzo	<b>DD</b>
Bianco nob.	Bianco nob.	<b>SS</b>

#### Laccato (LC + LC)

Bianco lucido	Bianco lucido	<b>EE</b>
---------------	---------------	-----------

Struttura Structure	Frontali Fronts	TFB009 _ _ _	TFB010 _ _ _
<b>NO</b>	<b>NO</b>	<b>87 €</b>	<b>175 €</b>
<b>NO</b>	<b>LC</b>	-	-
<b>LC</b>	<b>LC</b>	<b>97 €</b>	<b>199 €</b>

#### MANIGLIE / HANDLES

Modello / Model	Cod.
Maniglia M1	<b>M1</b>
Maniglia M2	<b>M2</b>

# GRUPPI BEDROOM SETS

Nota bene: tutti i gruppi sono dotati di guide a rotella  
Note: the bedroom sets are equipped with standard rail

## THAI

Completare il codice del prodotto con la sigla della **finitura** scelta.  
Complete the product code with the chosen finish code.

**Maniglia:** in metallo, finitura cromata.  
Metal handles in chromed finish.

Consegnato montato.  
Delivered assembled.

Disponibile kit ammortizzatore per guide optional.  
Optional soft closing available.

**Comodino THAI 1 cassetto e vano a giorno**  
Night stand THAI with 1 drawer and open unit

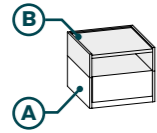

L52,6 - P44,6 - H43,7

**Comò THAI 2 cassetti e vano a giorno**  
Dresser THAI with 2 drawers and open unit

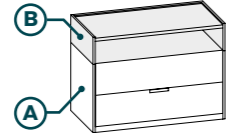

L106,6 - P44,6 - H77

**Settimino THAI 4 cassetti e vano a giorno**  
4 drawers unit THAI with open unit

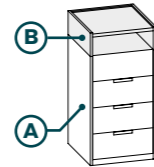

L52,6 - P44,6 - H107

### COMBINAZIONI FINITURE FINISHES COMBINATIONS

#### Nobilitato (NO + NO)

A	B	Codice Code
Orzo	Bianco altea	<b>DQ</b>
	Olmo natura	<b>DB</b>
	Noce biondo	<b>DR</b>
Bianco nobilitato	Bianco altea	<b>SQ</b>
	Olmo natura	<b>SB</b>
	Noce biondo	<b>SR</b>
Metallo oro	Bianco altea	<b>TQ</b>
	Olmo natura	<b>TB</b>
	Noce biondo	<b>TR</b>
Metallo argento	Bianco altea	<b>UQ</b>
	Olmo natura	<b>UB</b>
	Noce biondo	<b>UR</b>

#### Nobilitato e laccato (LC + NO)

Bianco lucido	Bianco altea	<b>EQ</b>
Bianco lucido	Olmo natura	<b>EB</b>
Bianco lucido	Noce biondo	<b>ER</b>

A	B	TFB012 __	TFB013 __	TFB014 __
NO	NO	<b>97 €</b>	<b>200 €</b>	<b>210 €</b>
LC	NO	<b>114 €</b>	<b>210 €</b>	<b>220 €</b>

## SCRIVANIA / DESK

Completare il codice del prodotto con la sigla della **finitura** scelta.  
Complete the product code with the chosen finish code.

**Pomolo:** in metallo, finitura titanio.  
Metal knob in titanium finish.

**Scrivania destra L150 con base frigo e fianco a L**  
L150 right desk with fridge base and L-shaped side

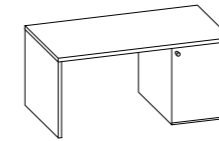

L150 - P60 - H72,5

**Scrivania sinistra L150 con base frigo e fianco a L**  
L150 left desk with fridge base and L-shaped side

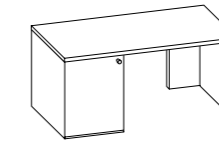

L150 - P60 - H72,5

Scrivania Desk	Frontale Door	TFB018 __	TFB019 __
NO	NO	<b>269 €</b>	<b>269 €</b>
NO	LC	<b>280 €</b>	<b>280 €</b>
LC	LC	-	-

### COMBINAZIONI FINITURE FINISHES COMBINATIONS

#### Nobilitato (NO + NO)

Scrivania Desk	Frontale Door	Codice Code
Bianco altea	Bianco altea	<b>QQ</b>
	Orzo	<b>QD</b>
	Argento	<b>QU</b>
	Oro	<b>QT</b>
Bianco nob.	Bianco nob.	<b>QS</b>
	Olmo natura	<b>BB</b>
	Orzo	<b>BD</b>
	Argento	<b>BU</b>
Oro	Oro	<b>BT</b>
	Bianco nob.	<b>BS</b>
	Noce biondo	<b>RR</b>
	Orzo	<b>RD</b>
Noce biondo	Argento	<b>RU</b>
	Oro	<b>RT</b>
	Bianco nob.	<b>RS</b>

#### Nobilitato e laccato (NO + LC)

Bianco altea	Bianco lucido	<b>QE</b>
Olmo natura	Bianco lucido	<b>BE</b>
Noce biondo	Bianco lucido	<b>RE</b>

## DUO

Completare il codice del prodotto con la sigla della **finitura** scelta.  
Complete the product code with the chosen finish code.

**Maniglia:** in metallo, finitura cromata.  
Metal handles in chromed finish.

Consegnato montato.  
Delivered assembled.

Disponibile kit ammortizzatore per guide optional.  
Optional soft closing available.

**Comodino DUO 2 cassetti**  
Night stand DUO with 2 drawers

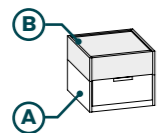

L52,6 - P44,6 - H43,7

**Comò DUO 3 cassetti**  
Dresser DUO with 3 drawers

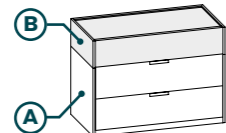

L106,6 - P44,6 - H77

**Settimino DUO 5 cassetti**  
5 drawers unit DUO

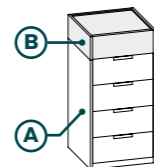

L52,6 - P44,6 - H107

#### Nobilitato (NO + NO)

A	B	Codice Code
Orzo	Bianco altea	<b>DQ</b>
	Olmo natura	<b>DB</b>
	Noce biondo	<b>DR</b>
Bianco nobilitato	Bianco altea	<b>SQ</b>
	Olmo natura	<b>SB</b>
	Noce biondo	<b>SR</b>
Metallo oro	Bianco altea	<b>TQ</b>
	Olmo natura	<b>TB</b>
	Noce biondo	<b>TR</b>
Metallo argento	Bianco altea	<b>UQ</b>
	Olmo natura	<b>UB</b>
	Noce biondo	<b>UR</b>

#### Nobilitato e laccato (LC + NO)

Bianco lucido	Bianco altea	<b>EQ</b>
Bianco lucido	Olmo natura	<b>EB</b>
Bianco lucido	Noce biondo	<b>ER</b>

A	B	TFB015 __	TFB016 __	TFB017 __
NO	NO	<b>118 €</b>	<b>225 €</b>	<b>235 €</b>
LC	NO	<b>134 €</b>	<b>240 €</b>	<b>250 €</b>

## SPECCHIERE E AMMORTIZZATORI / MIRRORS AND SOFT CLOSING KITS

**Specchiera WINDOW**  
WINDOW mirror



L69 - P2,2 - H91

**Specchiera ROLLER L**  
ROLLER L mirror

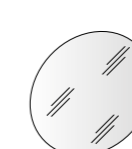

L70 - P2,2 - H70

**Kit ammortizzatori per cassetto comodino**  
Soft closing kit for night stand's drawer



**Kit ammortizzatori per cassetto comò**  
Soft closing kit for chest of drawers' drawer



Prezzo / Price

<b>TFB025</b>	<b>TFB026</b>	<b>AFB038</b>	<b>AFB039</b>
<b>66 €</b>	<b>99 €</b>	<b>15 €</b>	<b>19 €</b>

# LETTI BEDS

## REFLEX

### 160X190

Completare il codice del prodotto con la sigla della **finitura** scelta.  
Complete the product code with the chosen finish code.

Piede P31, giroletto GEMINI.  
P31 feet, GEMINI bedframe.

**Letto REFLEX per rete da 160x190, rete esclusa**  
Standard bed REFLEX for 160x190 bedspring (excluded)

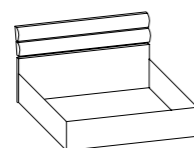

L169 - P205 - H90

**Letto REFLEX con rete fissa 160x190, rete inclusa**  
Standard bed REFLEX with 160x190 fixed bedspring included

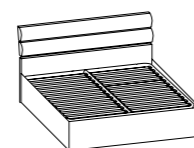

L169 - P205 - H90

**Letto REFLEX con rete contenitore 160x190, rete inclusa**  
Bed with box REFLEX with 160x190 bedspring included

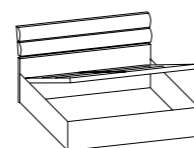

L169 - P205 - H90

### 160X200

**Letto REFLEX per rete da 160x200, rete esclusa**  
Standard bed REFLEX for 160x200 bedspring (excluded)

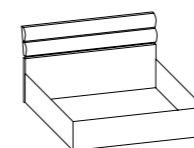

L169 - P215 - H90

**Letto REFLEX con rete fissa 160x200, rete inclusa / Standard bed REFLEX with 160x200 fixed bedspring included**

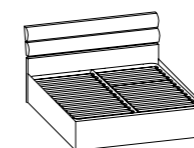

L169 - P215 - H90

**Letto REFLEX con rete contenitore 160x200, rete inclusa**  
Bed with box REFLEX with 160x200 bedspring included

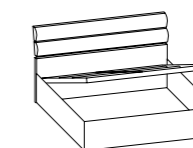

L169 - P215 - H90

Letto Bed      Testiera Headboard

		<b>BFB010 __</b>	<b>BFB011 __</b>	<b>BFB012 __</b>	<b>BFB013 __</b>	<b>BFB014 __</b>	<b>BFB015 __</b>
<b>NO</b>	<b>NO</b>	<b>249 €</b>	<b>349 €</b>	<b>449 €</b>	<b>259 €</b>	<b>359 €</b>	<b>459 €</b>
<b>NO</b>	<b>LC</b>	-	-	-	-	-	-
<b>LC</b>	<b>LC</b>	-	-	-	-	-	-

## COMBINAZIONI FINITURE FINISHES COMBINATIONS

### Nobilitato (NO + NO)

Letto Bed	Testiera Headboard	Codice Code
Bianco altea	Bianco altea	<b>QQ</b>
Olmo natura	Olmo natura	<b>BB</b>
Noce biondo	Noce biondo	<b>RR</b>

## VULCANO

### 160X190

Completare il codice del prodotto con la sigla della **finitura** scelta.  
Complete the product code with the chosen finish code.

Piede P31, giroletto GEMINI.  
P31 feet, GEMINI bedframe.

**Letto VULCANO per rete da 160x190, rete esclusa**  
Standard bed VULCANO for 160x190 bedspring (excluded)

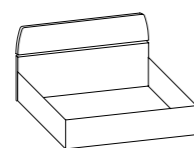

L169 - P205 - H94

**Letto VULCANO con rete fissa 160x190, rete inclusa**  
Standard bed VULCANO with 160x190 fixed bedspring included

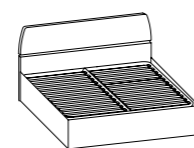

L169 - P205 - H94

**Letto VULCANO con rete contenitore 160x190, rete inclusa**  
Bed with box VULCANO with 160x190 bedspring included

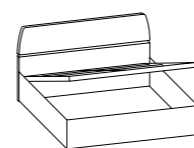

L169 - P205 - H94

### 160X200

**Letto VULCANO per rete da 160x200, rete esclusa**  
Standard bed VULCANO for 160x200 bedspring (excluded)

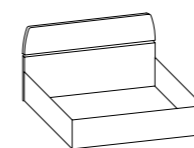

L169 - P215 - H94

**Letto VULCANO con rete fissa 160x200, rete inclusa / Standard bed VULCANO with 160x200 fixed bedspring included**

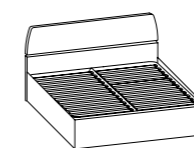

L169 - P215 - H94

**Letto VULCANO con rete contenitore 160x200, rete inclusa**  
Bed with box VULCANO with 160x200 bedspring included



L169 - P215 - H94

Letto Bed      Testiera Headboard

		<b>BFB031 __</b>	<b>BFB032 __</b>	<b>BFB033 __</b>	<b>BFB034 __</b>	<b>BFB035 __</b>	<b>BFB036 __</b>
<b>NO</b>	<b>NO</b>	<b>208 €</b>	<b>308 €</b>	<b>478 €</b>	<b>219 €</b>	<b>319 €</b>	<b>499 €</b>
<b>NO</b>	<b>LC</b>	-	-	-	-	-	-
<b>LC</b>	<b>LC</b>	<b>255 €</b>	<b>355 €</b>	<b>524 €</b>	<b>265 €</b>	<b>365 €</b>	<b>545 €</b>

## COMBINAZIONI FINITURE FINISHES COMBINATIONS

### Nobilitato (NO + NO)

Letto Bed	Testiera Headboard	Codice Code
Bianco altea	Bianco altea	<b>QQ</b>
Olmo natura	Olmo natura	<b>BB</b>
Noce biondo	Noce biondo	<b>RR</b>
Bianco nob.	Bianco nob.	<b>SS</b>

### Laccato (LC + LC)

Bianco lucido	Bianco lucido	<b>EE</b>
---------------	---------------	-----------



# LETTI BEDS

## METIZ

### 160X190

Completare il codice del prodotto con la sigla della finitura scelta.  
Complete the product code with the chosen finish code.

Piede P30, giroletto GIGLIO.  
P30 feet, GIGLIO bedframe.

Piede P31, giroletto GEMINI.  
P31 feet, GEMINI bedframe.

**Letto METIZ-GIGLIO per rete da 160x190, rete esclusa**  
Standard bed METIZ-GIGLIO for 160x190 bedspring (excluded)

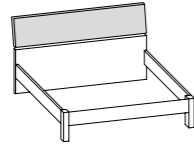

L169 - P202 - H94

**Letto METIZ-GIGLIO con rete fissa 160x190, rete inclusa**  
Standard bed METIZ-GIGLIO with 160x190 fixed bedspring included

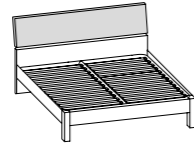

L169 - P202 - H94

**Letto METIZ-GEMINI per rete da 160x190, rete esclusa**  
Standard bed METIZ-GEMINI for 160x190 bedspring (excluded)

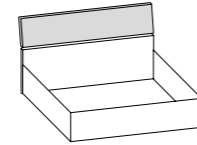

L169 - P202 - H94

**Letto METIZ-GEMINI con rete fissa 160x190, rete inclusa**  
Standard bed METIZ-GEMINI with 160x190 fixed bedspring included

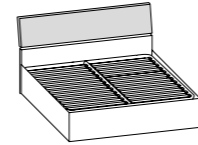

L169 - P202 - H94

**Letto METIZ-GEMINI con rete contenitore 160x190, rete inclusa**  
Bed with box METIZ-GEMINI with 160x190 bedspring included

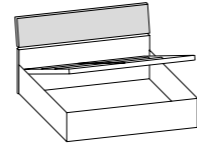

L169 - P202 - H94

### 160X200

**Letto METIZ-GEMINI per rete da 160x200, rete esclusa**  
Standard bed METIZ-GEMINI for 160x200 bedspring (excluded)

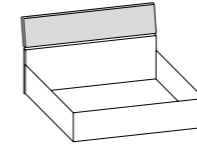

L169 - P212 - H94

**Letto METIZ-GEMINI con rete fissa 160x200, rete inclusa / Standard bed METIZ-GEMINI with 160x200 fixed bedspring included**

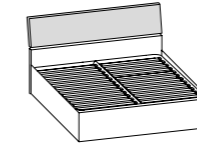

L169 - P212 - H94

**Letto METIZ-GEMINI con rete contenitore 160x200, rete inclusa**  
Bed with box METIZ-GEMINI with 160x200 bedspring included

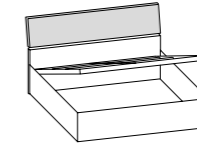

L169 - P212 - H94

Letto Bed      Pannello testiera Headb. panel

		<b>BFB043 __</b>	<b>BFB044 __</b>	<b>BFB007 __</b>	<b>BFB008 __</b>	<b>BFB009 __</b>	<b>BFB025 __</b>	<b>BFB026 __</b>	<b>BFB027 __</b>
<b>NO</b>	<b>NO</b>	<b>150 €</b>	<b>275 €</b>	<b>211 €</b>	<b>299 €</b>	<b>482 €</b>	<b>221 €</b>	<b>301 €</b>	<b>491 €</b>
<b>NO</b>	<b>LC</b>	<b>175 €</b>	<b>300 €</b>	<b>236 €</b>	<b>319 €</b>	<b>499 €</b>	<b>246 €</b>	<b>326 €</b>	<b>516 €</b>
<b>LC</b>	<b>LC</b>	-	-	<b>262 €</b>	<b>339 €</b>	<b>532 €</b>	<b>271 €</b>	<b>351 €</b>	<b>541 €</b>

## METIZ

### 150X190

Completare il codice del prodotto con la sigla della finitura scelta.  
Complete the product code with the chosen finish code.

Piede P31, giroletto GEMINI.  
P31 feet, GEMINI bedframe.

**Letto METIZ-GEMINI per rete da 150x190, rete esclusa**  
Standard bed METIZ-GEMINI for 150x190 bedspring (excluded)

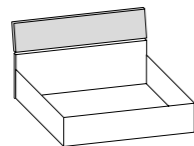

L159 - P202 - H94

**Letto METIZ-GEMINI con rete fissa 150x190, rete inclusa**  
Standard bed METIZ-GEMINI with 150x190 fixed bedspring included

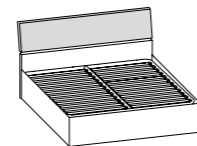

L159 - P202 - H94

**Letto METIZ-GEMINI con rete contenitore 150x190, rete inclusa**  
Bed with box METIZ-GEMINI with 150x190 bedspring included

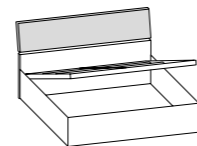

L159 - P202 - H94

### 180X200

**Letto METIZ-GEMINI per rete da 180x200, rete esclusa**  
Standard bed METIZ-GEMINI for 180x200 bedspring (excluded)

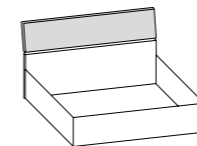

L189 - P212 - H94

**Letto METIZ-GEMINI con rete fissa 180x200, rete inclusa / Standard bed METIZ-GEMINI with 180x200 fixed bedspring included**

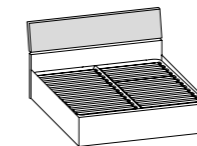

L189 - P212 - H94

**Letto METIZ-GEMINI con rete contenitore 180x200, rete inclusa**  
Bed with box METIZ-GEMINI with 180x200 bedspring included

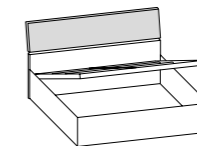

L189 - P212 - H94

Letto Bed      Pannello testiera Headb. panel

		<b>BFB016 __</b>	<b>BFB017 __</b>	<b>BFB018 __</b>	<b>BFB028 __</b>	<b>BFB029 __</b>	<b>BFB030 __</b>
<b>NO</b>	<b>NO</b>	<b>201 €</b>	<b>289 €</b>	<b>472 €</b>	<b>242 €</b>	<b>322 €</b>	<b>533 €</b>
<b>NO</b>	<b>LC</b>	<b>226 €</b>	<b>309 €</b>	<b>489 €</b>	<b>267 €</b>	<b>347 €</b>	<b>558 €</b>
<b>LC</b>	<b>LC</b>	<b>252 €</b>	<b>329 €</b>	<b>522 €</b>	<b>292 €</b>	<b>372 €</b>	<b>583 €</b>

## COMBINAZIONI FINITURE FINISHES COMBINATIONS

### Nobilitato (NO + NO)

Letto Bed	Pann. testiera Headb. panel	Codice Code
Bianco altea	Bianco altea	<b>QQ</b>
	Bianco nob.	<b>QS</b>
	Orzo	<b>QD</b>
	Argento	<b>QU</b>
Olmo natura	Oro	<b>QT</b>
	Olmo natura	<b>BB</b>
	Bianco nob.	<b>BS</b>
	Orzo	<b>BD</b>
Noce biondo	Argento	<b>BU</b>
	Oro	<b>BT</b>
	Noce biondo	<b>RR</b>
	Bianco nob.	<b>RS</b>
Bianco nob.	Orzo	<b>RD</b>
	Argento	<b>RU</b>
	Oro	<b>RT</b>
	Bianco altea	<b>SQ</b>
Bianco nob.	Olmo natura	<b>SB</b>
	Noce biondo	<b>SR</b>
	Bianco nob.	<b>SS</b>
	Orzo	<b>SD</b>
Bianco nob.	Argento	<b>SU</b>
	Oro	<b>ST</b>

### Nobilitato e laccato (NO + LC)

Letto Bed	Pann. testiera Headb. panel	Codice Code
Bianco altea	Bianco lucido	<b>QE</b>
Olmo natura	Bianco lucido	<b>BE</b>
Noce biondo	Bianco lucido	<b>RE</b>

### Laccato (LC + LC)

Letto Bed	Pann. testiera Headb. panel	Codice Code
Bianco lucido	Bianco lucido	<b>EE</b>

# LETTI BEDS

## SLIM

Completare il codice del prodotto con la sigla della **finitura** scelta.  
Complete the product code with the chosen finish code.

Piede P31, giroletto GEMINI.  
P31 feet, GEMINI bedframe.

**Libreria optional / Optional bookcase**

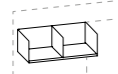

L55 - P18 - H18

**AFB048 \_ 49 €**

**Luce optional / Optional light**



**AFB062 119 €**

Letto Bed      Testiera Headboard

**NO NO**

**NO LC**

**NO CA**

## 160X190

**Letto SLIM per rete da 160x190, rete esclusa**  
Standard bed SLIM for 160x190 bedspring (excluded)

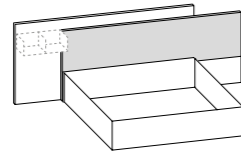

L280,2 - P200 - H100

**Letto SLIM con rete fissa 160x190, rete inclusa**  
Standard bed SLIM with 160x190 fixed bedspring included

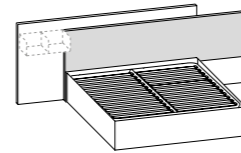

L280,2 - P200 - H100

**Letto SLIM con rete contenitore 160x190, rete inclusa**  
Bed with box SLIM with 160x190 bedspring included

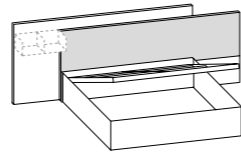

L280,2 - P200 - H100

## 160X200

**Letto SLIM per rete da 160x200, rete esclusa**  
Standard bed SLIM with 160x200 bedspring (excluded)

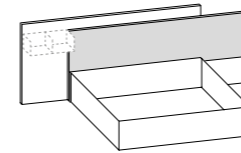

L280,2 - P210 - H100

**Letto SLIM con rete fissa 160x200, rete inclusa**  
Standard bed SLIM with 160x200 fixed bedspring included

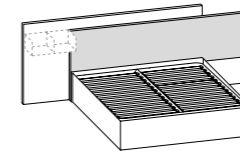

L280,2 - P210 - H100

**Letto SLIM con rete contenitore 160x200, rete inclusa**  
Bed with box SLIM with 160x200 bedspring included

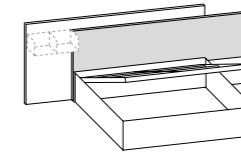

L280,2 - P210 - H100

**BFB001 \_\_**

**250 €**

**BFB002 \_\_**

**381 €**

**BFB003 \_\_**

**431 €**

**BFB019 \_\_**

**259 €**

**BFB020 \_\_**

**390 €**

**BFB021 \_\_**

**438 €**

**269 €**

**400 €**

**450 €**

**278 €**

**409 €**

**457 €**

**319 €**

**450 €**

**498 €**

**328 €**

**459 €**

**507 €**

## COMBINAZIONI FINITURE FINISHES COMBINATIONS

### Nobilitato (NO + NO)

Letto Bed	Testiera Headboard	Codice Code
Bianco altea	Bianco nob.	<b>QS</b>
	Orzo	<b>QD</b>
	Argento	<b>QU</b>
	Oro	<b>QT</b>
	Bianco nob.	<b>BS</b>
	Orzo	<b>BD</b>
Olmo natura	Argento	<b>BU</b>
	Oro	<b>BT</b>
Noce biondo	Bianco nob.	<b>RS</b>
	Orzo	<b>RD</b>
	Argento	<b>RU</b>
	Oro	<b>RT</b>

### Nobilitato e laccato (NO + LC)

Letto Bed	Testiera Headboard	Codice Code
Bianco altea	Bianco lucido	<b>QE</b>
Olmo natura	Bianco lucido	<b>BE</b>
Noce biondo	Bianco lucido	<b>RE</b>

### Nobilitato ed ecop. Cali (NO + CA)

Letto Bed	Testiera Headboard	Codice Code
Bianco altea	Cali Bianco	<b>QJ</b>
	Cali Fango	<b>QK</b>
Olmo natura	Cali Bianco	<b>BJ</b>
	Cali Fango	<b>BK</b>
Noce biondo	Cali Bianco	<b>RJ</b>
	Cali Fango	<b>RK</b>

### Finitura libreria optional

Finiture libreria Bookcase finishes	Codice Code
Bianco altea	<b>Q</b>
Olmo natura	<b>B</b>
Noce biondo	<b>N</b>
Orzo	<b>D</b>
Oro	<b>T</b>
Argento	<b>U</b>
Bianco nobilitato	<b>S</b>

## SLIM

Completare il codice del prodotto con la sigla della **finitura** scelta.  
Complete the product code with the chosen finish code.

Piede P31, giroletto GEMINI.  
P31 feet, GEMINI bedframe.

**Libreria optional / Optional bookcase**

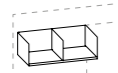

L55 - P18 - H18

**AFB048 \_ 49 €**

**Luce optional / Optional light**



**AFB062 119 €**

Letto Bed      Testiera Headboard

**NO NO**

**NO LC**

**NO CA**

## 150X190

**Letto SLIM per rete da 150x190, rete esclusa**  
Standard bed SLIM for 150x190 bedspring (excluded)

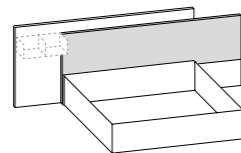

L270,2 - P200 - H100

**Letto SLIM con rete fissa 150x190, rete inclusa**  
Standard bed SLIM with 150x190 fixed bedspring included

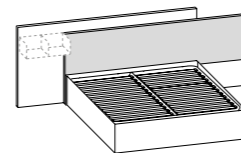

L270,2 - P200 - H100

**Letto SLIM con rete contenitore 150x190, rete inclusa**  
Bed with box SLIM with 150x190 bedspring included

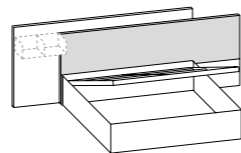

L270,2 - P200 - H100

## 180X200

**Letto SLIM per rete da 180x200, rete esclusa**  
Standard bed SLIM for 180x200 bedspring (excluded)

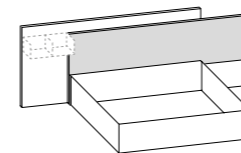

L300,2 - P210 - H100

**Letto SLIM con rete fissa 180x200, rete inclusa**  
Standard bed SLIM with 180x200 fixed bedspring included

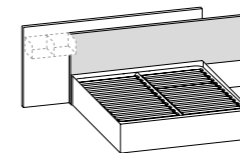

L300,2 - P210 - H100

**Letto SLIM con rete contenitore 180x200, rete inclusa**  
Bed with box SLIM with 180x200 bedspring included

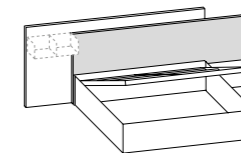

L300,2 - P210 - H100

**BFB004 \_\_**

**250 €**

**BFB005 \_\_**

**381 €**

**BFB006 \_\_**

**431 €**

**BFB022 \_\_**

**281 €**

**BFB023 \_\_**

**432 €**

**BFB024 \_\_**

**467 €**

**269 €**

**400 €**

**450 €**

**300 €**

**451 €**

**480 €**

**319 €**

**450 €**

**498 €**

**350 €**

**501 €**

**549 €**

# LETTI IMBOTTITI

## UPHOLSTERED BEDS

### RIGEL

Completare il codice del prodotto con la sigla della **finitura** scelta.  
Complete the product code with the chosen finish code.

Piede P42, giroletto G25.  
P42 feet, G25 bedframe.

**Letto RIGEL con rete contenitore 160x190, rete inclusa**  
Bed with box RIGEL with 160x190 bedspring included

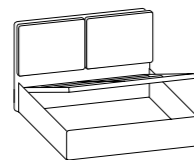

L186 - P205 - H115

Letto  
Bed

**BFB038 \_ \_**

**LR**

**581 €**

### COMBINAZIONI FINITURE

FINISHES COMBINATIONS

#### Ecopelle Lira (LR)

Letto Bed	Codice Code
Lira bianco	<b>VV</b>
Lira tortora	<b>WW</b>

### ESEDRA BASIC

Completare il codice del prodotto con la sigla della **finitura** scelta.  
Complete the product code with the chosen finish code.

Piede P42, giroletto G25.  
P42 feet, G25 bedframe.

**Letto ESEDRA BASIC con rete contenitore 160x190, rete inclusa**  
Bed with box ESEDRA BASIC with 160x190 bedspring included

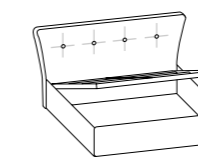

L192 - P206 - H99

Letto  
Bed

**BFB040 \_ \_**

**CT**

**600 €**

### COMBINAZIONI FINITURE

FINISHES COMBINATIONS

#### Nabuk Cetra (CT)

Letto Bed	Codice Code
Cetra beige	<b>XX</b>
Cetra antracite	<b>YY</b>

### MISAM

Completare il codice del prodotto con la sigla della **finitura** scelta.  
Complete the product code with the chosen finish code.

Piede P42, giroletto G25.  
P42 feet, G25 bedframe.

**Letto MISAM con rete contenitore 160x190, rete inclusa**  
Bed with box MISAM with 160x190 bedspring included

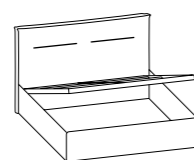

L198 - P210 - H110

Letto  
Bed

**BFB039 \_ \_**

**LR**

**581 €**

### ERA BASIC

Completare il codice del prodotto con la sigla della **finitura** scelta.  
Complete the product code with the chosen finish code.

Piede P42, giroletto G25.  
P42 feet, G25 bedframe.

**Letto ERA BASIC con rete contenitore 160x190, rete inclusa**  
Bed with box ERA BASIC with 160x190 bedspring included

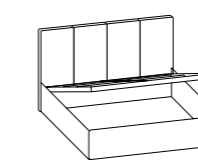

L174 - P219 - H109

Letto  
Bed

**BFB041 \_ \_**

**CT**

**600 €**

### ATIK

Completare il codice del prodotto con la sigla della **finitura** scelta.  
Complete the product code with the chosen finish code.

Piede P42, giroletto G25.  
P42 feet, G25 bedframe.

**Letto ATIK con rete contenitore 160x190, rete inclusa**  
Bed with box ATIK with 160x190 bedspring included

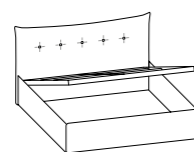

L195 - P210 - H126

Letto  
Bed

**BFB037 \_ \_**

**LR**

**581 €**

### DIONE BASIC

Completare il codice del prodotto con la sigla della **finitura** scelta.  
Complete the product code with the chosen finish code.

Piede P42, giroletto G25.  
P42 feet, G25 bedframe.

**Letto DIONE BASIC con rete contenitore 160x190, rete inclusa**  
Bed with box DIONE BASIC with 160x190 bedspring included

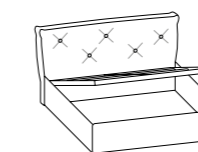

L194 - P211 - H112

Letto  
Bed

**BFB042 \_ \_**

**CT**

**690 €**

# ACCESSORI INTERNI PER ARMADI

## INTERNAL ACCESSORIES FOR WARDROBES

### Ripiani interni

Shelves

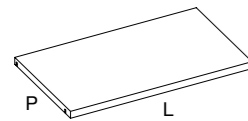

L43,6 - P50 - H2,5	L45	<b>AFB006</b>	35 €
L89 - P50 - H2,5	L90	<b>AFB007</b>	39 €
L120 - P50 - H2,5	L120	<b>AFB031</b>	60 €
L135 - P50 - H2,5	L135	<b>AFB032</b>	64 €

### Ripiano interno per elemento ponte

Shelf for bridge unit

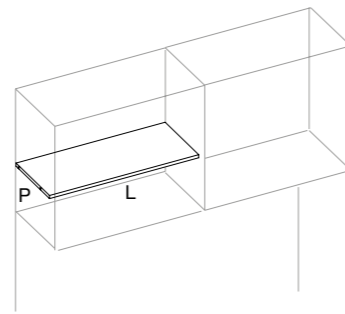

L111,7 - P50 - H2,5	Ponte	<b>AFB013</b>	65 €
---------------------	-------	---------------	------

### Cassettiera interna con 2 cassetti

2 drawers unit

Guide a rotella non ammortizzata  
Standard rails without soft closing

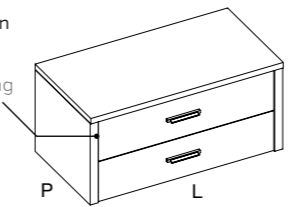

L89 - P44,1 - H39,2	L90	<b>AFB045</b>	99 €
---------------------	-----	---------------	------

### Cassettiera interna con 3 cassetti

3 drawers unit

Guide a rotella non ammortizzata  
Standard rails without soft closing

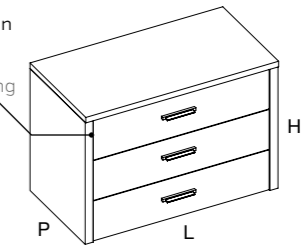

L89 - P44,1 - H57,4	L90	<b>AFB020</b>	116 €
---------------------	-----	---------------	-------

### Ripiano interno per cabina

Shelf for clothes closet unit

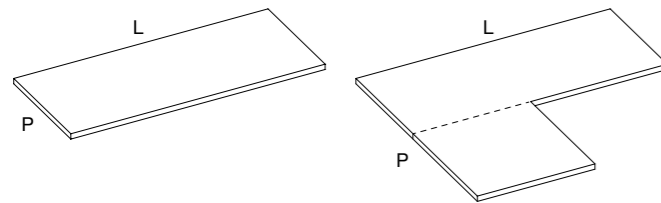

L115,3 - P44,6 - H2,5	Cabina	<b>AFB009</b>	56 €
L115,3 - P115,3 - H2,5	Ripiano a L	<b>AFB040</b>	67 €

### Ripiano interno per angolo

Shelf for corner unit

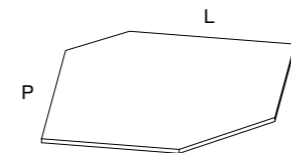

L82,9 - P82,9 - H2,5	Angolo	<b>AFB010</b>	64 €
----------------------	--------	---------------	------

### Portacravatte estraibile

Pull-out ties rack

Guide a rotella non ammortizzata  
Standard rails without soft closing

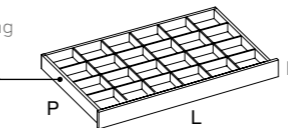

L89 - P49,6 - H7,5	L90	<b>AFB018</b>	164 €
--------------------	-----	---------------	-------

### Portapantaloni estraibile

Pull-out trousers rack

Guide a rotella non ammortizzata  
Standard rails without soft closing

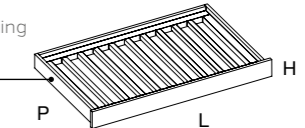

L89 - P49,6 - H7,5	L90	<b>AFB019</b>	138 €
--------------------	-----	---------------	-------

### Ripiano interno per terminale

Shelf for end unit

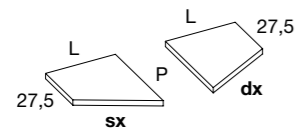

L37,6 - P50 - H2,5	Destro	<b>AFB011</b>	35 €
L37,6 - P50 - H2,5	Sinistro	<b>AFB012</b>	35 €

### Insero con ripiani per vano da 120 e 135

Internal partition for 120 and 135 units

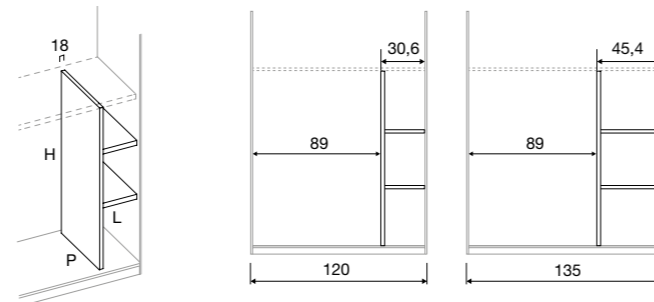

L30,6 - P50 - H112,4	L120	<b>AFB036</b>	59 €
L45,5 - P50 - H112,4	L135	<b>AFB037</b>	66 €

### Vassoio estraibile

Pull-out tray

Guide a rotella non ammortizzata  
Standard rails without soft closing

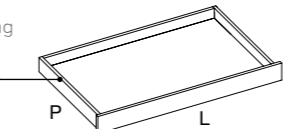

L89 - P49,6 - H7,5	L90	<b>AFB063</b>	163 €
--------------------	-----	---------------	-------

### Tubi appendiabito

Hanger tubes

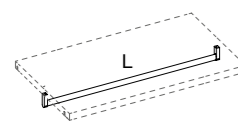

L42,8	L45	<b>AFB014</b>	13 €
L88,2	L90	<b>AFB015</b>	15 €
L118,8	L120	<b>AFB033</b>	17 €
L133,6	L135	<b>AFB034</b>	18 €
L114,5	Cabina	<b>AFB016</b>	15 €
L83,3	Angolo	<b>AFB017</b>	15 €

### Meccanismo appendiabiti in metallo con tubo telescopico

Metal pull-out hanger with telescopic tube

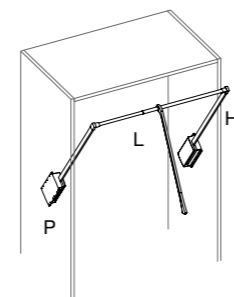

L89 - P14 - H87	L90-120	<b>AFB021</b>	123 €
-----------------	---------	---------------	-------

## ACCESSORI - ILLUMINAZIONE

### ACCESSORIES - LIGHTING

#### Luce led interna

Internal led light

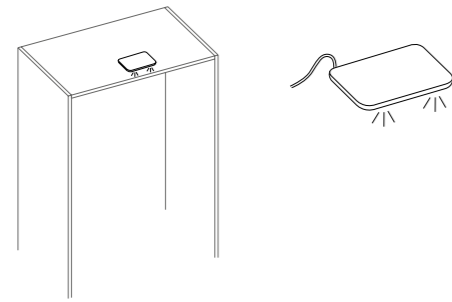

tutti i vani **AFB023** 145 €

#### Barra led per sottoponte

Led bar for bridge unit

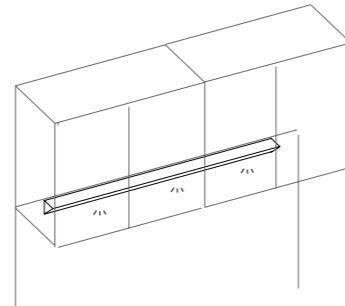

ponte **AFB024** 177 €

## ACCESSORI VARI

### OTHER ACCESSORIES

#### Kit piedini livellatori (4 piedini)

Adjustable legs kit (4 legs)

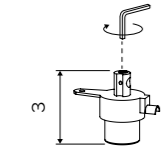

Armadi battenti  
Hinged doors wardrobes

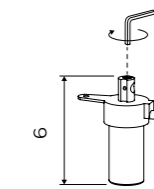

Armadio scorrevole  
Sliding doors wardrobe

Battente	<b>AFB025</b>	15 €
Cabina	<b>AFB058</b>	15 €
Ponte	<b>AFB059</b>	15 €
Scorrevole	<b>AFB026</b>	15 €

#### Ammortizzatori per ante battenti

Soft closing for hinged doors



Kit N.1 ammortizzatore per anta ponte Kit N.1 soft closing for bridge unit's door	<b>AFB027</b>	9 €
Kit N.2 ammortizzatori per anta battente Kit N.2 soft closing for hinged door	<b>AFB046</b>	17 €

#### Ammortizzatori per ante scorrevoli

Soft closing for sliding doors

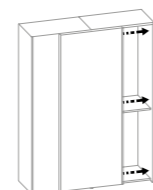

Per armadio 2 ante / For 2 doors wardrobe	<b>AFB028</b>	26 €
Per armadio 3 ante / For 3 doors wardrobe	<b>AFB047</b>	36 €

#### Specchio interno sp.3mm

Internal mirror thickness 3mm



L36 - H166 - **AFB022** 46 €

## FASCE DI TAMPONAMENTO E PANNELLI

### FILLERS AND PANELS

#### FASCE DI TAMPONAMENTO PER ANGOLO E ARMADIO SCORREVOLE / FILLERS FOR CORNER-SLIDING DOORS WARDROBES FLANKING

In caso di affiancamento di armadi scorrevoli con angoli e cabine, inserire una fascia di tamponamento da 6cm tra l'armadio scorrevole e l'angolo/cabina per garantire l'apertura dell'anta battente.  
In case of flanking between sliding doors wardrobes and corner/closet units, we advise to insert a 6cm-wide filler between the two wardrobes to guarantee the hinged doors opening.

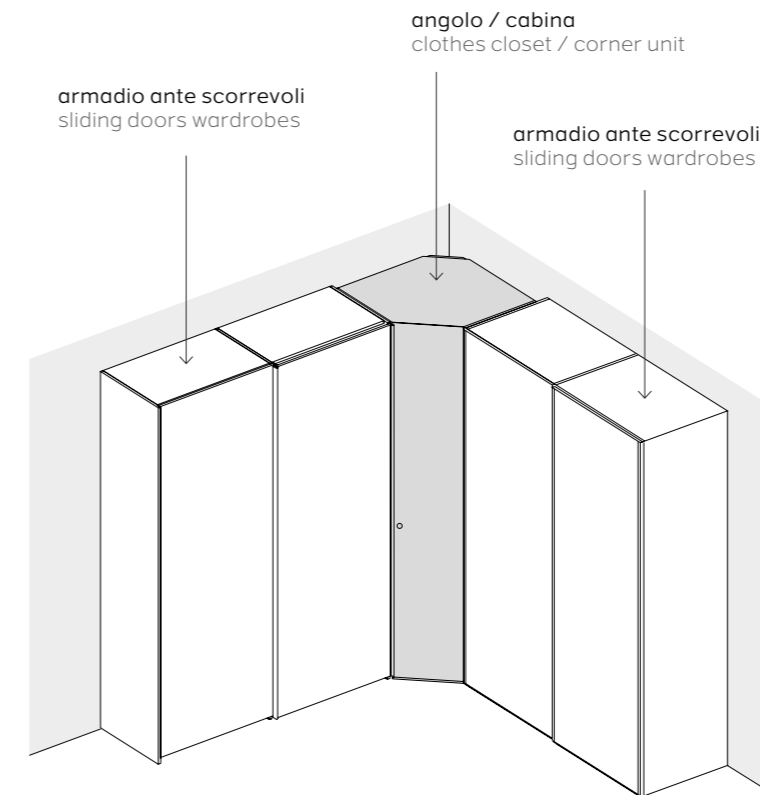

scostamento angolo da muro, per affiancamento a lato lungo armadio scorrevole. span from wall to corner unit. Used when the corner unit is next to the sliding doors wardrobe's deeper side.

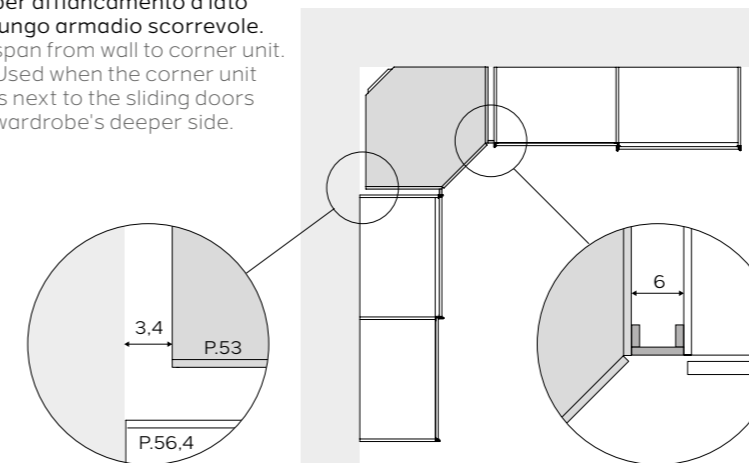

distanziale di 6cm per consentire l'apertura dell'angolo  
6cm-wide filler to allow the door's opening

Completare il codice del prodotto con la sigla della finitura scelta.  
Complete the product code with the chosen finish code.

#### H245

	<b>AFB029 _</b>
<b>NO</b>	73 €
<b>LC</b>	100 €

#### H225

	<b>AFB030 _</b>
<b>NO</b>	73 €
<b>LC</b>	100 €

#### COMBINAZIONI FINITURE

FINISHES COMBINATIONS

#### Nobilitato (NO)

Finitura Finish	Codice Code
Bianco altea	<b>Q</b>
Olmo natura	<b>B</b>
Noce biondo	<b>R</b>
Bianco nobilitato	<b>S</b>
Orzo	<b>D</b>
Argento	<b>U</b>
Oro	<b>T</b>

#### Laccato (LC)

Finitura Finish	Codice Code
Bianco lucido	<b>E</b>

# FASCE DI TAMPONAMENTO E PANNELLI

## FILLERS AND PANELS

### FASCIA DI TAMPONAMENTO LATERALE FISSA / FIXED LATERAL FILLER

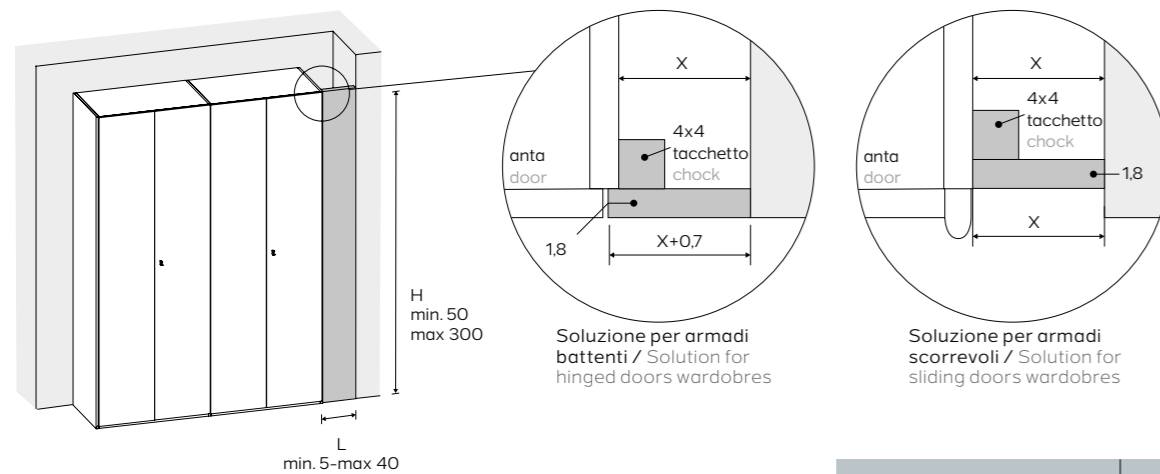

Prezzo al metro lineare.  
Il prezzo minimo calcolato è di 0,6 metri lineari

Price per linear metre.  
Minimum price is for 0,6 linear meter

Essenza / Nobilitato	<b>2FBFMI01</b>	112 €
Laccato	<b>2FBFMI02</b>	122 €

### PANNELLI AL METRO QUADRO / SQUARE METRE PANELS

**Essenza e Nobilitati**  
Wood and melamine

**Laccati (1 lato)**  
Lacquered (1 side)

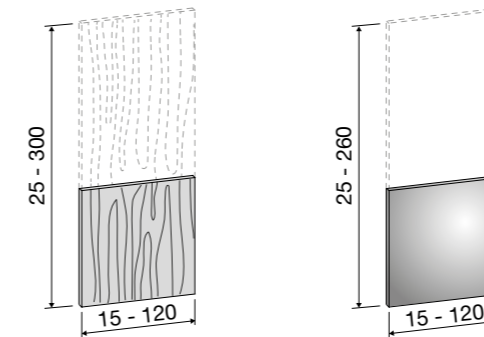

Pannello fornito squadrato e bordato sui 4 lati. Il prezzo minimo calcolato è quello di 0,4 mq di pannello

Provided with edge in each side. The minimum price is calculated on 0,4 square metres.

		Tessuto	NO	LC
Essenza / Nobilitato / Laccato	<b>2FBFMI07</b>	-	100 €	125 €
Tessuto Glamour (finitura interni)	<b>2FBFMI08</b>	100 €	-	-

Ferramenta per pannello al mq / Hardware for square metre panel	<b>AFB049</b>	15 €
---	---------------	------

### TAMPONAMENTO APRIBILE / OPENABLE FILLER

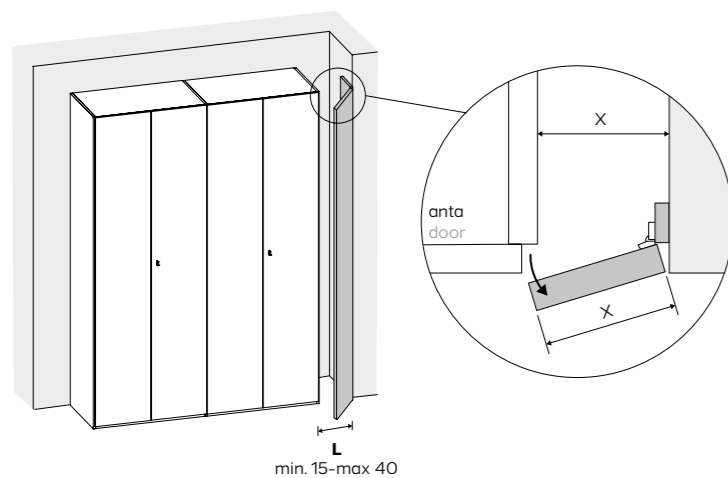

L'anta del tamponamento è senza maniglia con apertura push-pull. Il tamponamento apribile è composto da fascia per fissaggio a muro e anta (dx o sx).

The openable filler is equipped with push-pull opening. It's composed of a panel attached to the wall and a door with push-pull opening.

Essenza / Nobilitato	<b>2FBFMI03</b>	55 €
Laccato	<b>2FBFMI04</b>	60 €

### BORDI E RITOCCHI / EDGES AND PAINT KIT

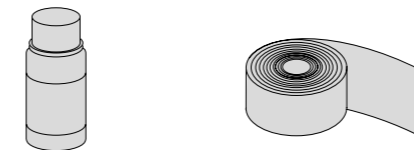

Bordi (bobina da 4 metri) / Edges (4 metres bobbin)	<b>2FBFMI09</b>	8 €
Bocchetta ritocco / Paint kit	<b>2FBFMI10</b>	8 €

### FASCIA DI TAMPONAMENTO SUPERIORE FISSA / FIXED SUPERIOR FILLER SOLO PER ARMADI BATTENTI / ONLY FOR HINGED DOORS UNITS

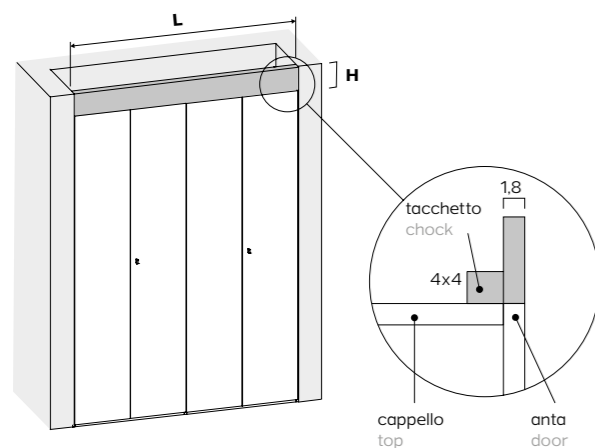

Prezzo al metro lineare.  
Il prezzo minimo calcolato è di 0,6 metri lineari

Price per linear metre.  
Minimum price is for 0,6 linear meter

Essenza / Nobilitato	<b>2FBFMI05</b>	55 €
Laccato	<b>2FBFMI06</b>	60 €

### LAVORAZIONE EXTRA STANDARD / EXTRA-STANDARD PROCESSING

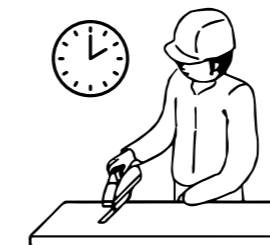

Una lavorazione Extra-standard viene fatta su richiesta e deve essere valutata e avallata dall'ufficio tecnico Imab.

An Extra-standard processing must be confirmed by Imab's technical office.

Costo orario / Hourly cost	<b>2FBFMI140</b>	100 €
----------------------------	------------------	-------

**AMMORTIZZATORI PER COMÒ E COMODINI / SOFT CLOSING KITS FOR NIGHT STANDS AND CHESTS OF DRAWERS**

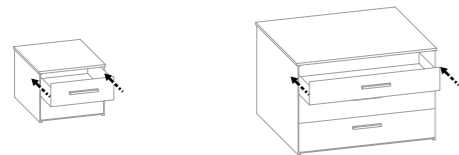

Per gruppi  
Cady, Small, Thai e Duo.

For Cady, Small, Thai and  
Duo bedroom sets

Kit ammortizzatori per cassetto comodino Soft closing kit for night stand's drawer	<b>AFB038</b>	15 €
Kit ammortizzatori per cassetto comò Soft closing kit for chest of drawers' drawer	<b>AFB039</b>	19 €

**RETI / BED SPRINGS**

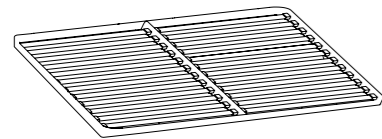

Reti matrimoniali basic plane  
(senza piedi) a doga intera.

Basic queen-size bedsprings  
without feet, unique slat.

Rete 160x190 / 160x190 bedspring	<b>AFB067</b>	139 €
Rete 160x200 / 160x200 bedspring	<b>AFB068</b>	149 €
Rete 180x200 / 180x200 bedspring	<b>AFB069</b>	199 €
Rete 150x190 / 150x190 bedspring	<b>AFB070</b>	139 €

# COMPOSITIONS



**COMPOSIZIONI A CATALOGO**  
CATALOGUE COMPOSITIONS

<b>VFB005</b>	<b>1.881 €</b>	<b>Codice</b> Code	<b>Descrizione</b> Description	<b>Finitura</b> Finish	<b>QT.</b>	<b>€</b>
	<b>RFB024BS</b>	Armadio H245 3 ante scorrevoli L90 con specchio centrale 3 L90 sliding doors wardrobe H245 with mirror door	Olmo natura Bianco nobilitato	1	978	
	<b>TFB006SS</b>	Comodino AUX 2 cassetti Night stand AUX with 2 drawers	Bianco nobilitato	2	210	
	<b>TFB007SS</b>	Comò AUX 3 cassetti Dresser AUX with 3 drawers	Bianco nobilitato	1	178	
	<b>BFB012BB</b>	Letto REFLEX con rete contenitore 160x190, rete inclusa Bed with box REFLEX with 160x190 bedspring included	Olmo natura	1	449	
	<b>TFB025</b>	Specchiera WINDOW WINDOW mirror	-	1	66	

<b>VFB002</b>	<b>1.879 €</b>	<b>Codice</b> Code	<b>Descrizione</b> Description	<b>Finitura</b> Finish	<b>QT.</b>	<b>€</b>
	<b>RFB024QQ</b>	Armadio H245 3 ante scorrevoli L90 con specchio centrale 3 L90 sliding doors wardrobe H245 with mirror door	Bianco altea	1	978	
	<b>TFB003QUM1</b>	Comodino SMALL 2 cassetti Night stand SMALL with 2 drawers	Bianco altea Metallo argento	2	174	
	<b>TFB004QUM1</b>	Comò SMALL 3 cassetti Dresser SMALL with 3 drawers	Bianco altea Metallo argento	1	181	
	<b>BFB003QU</b>	Letto SLIM con rete contenitore 160x190, rete inclusa Bed with box SLIM with 160x190 bedspring included	Bianco altea Metallo argento	1	431	
	<b>AFB048U</b>	Libreria optional per letto SLIM Optional bookcase for SLIM bed	Metallo argento	1	49	
	<b>TFB025</b>	Specchiera WINDOW WINDOW mirror	Bianco altea	1	66	

<b>VFB003</b>	<b>1.618 €</b>	<b>Codice</b> Code	<b>Descrizione</b> Description	<b>Finitura</b> Finish	<b>QT.</b>	<b>€</b>
	<b>RFB006RTM2</b>	Armadio H245 6 ante 6 doors wardrobe H245	Noce biondo Metallo oro	1	522	
	<b>TFB001RTM2</b>	Comodino CADY 2 cassetti Night stand CADY with 2 drawers	Noce biondo Metallo oro	2	198	
	<b>TFB002RTM2</b>	Comò CADY 3 cassetti Dresser CADY with 3 drawers	Noce biondo Metallo oro	1	199	
	<b>BFB041XX</b>	Letto ERA BASIC con rete contenitore 160x190, rete inclusa Bed with box ERA BASIC with 160x190 bedspring included	Cetra beige	1	600	
	<b>TFB026</b>	Specchiera ROLLER L ROLLER L mirror	-	1	99	

<b>VFB016</b>	<b>2.005 €</b>	<b>Codice</b> Code	<b>Descrizione</b> Description	<b>Finitura</b> Finish	<b>QT.</b>	<b>€</b>
	<b>RFB002QQM1</b>	Armadio H245 2 ante 2 doors wardrobe H245	Bianco altea	2	440	
	<b>RFB002QUM1</b>	Armadio H245 2 ante 2 doors wardrobe H245	Bianco altea Metallo argento	1	220	
	<b>AFB001Q</b>	Libreria H245 L35 Bookcase L35 H245	Bianco altea	2	436	
	<b>TFB012UQ</b>	Comodino THAI 1 cassetto e vano a giorno Night stand THAI with 1 drawer and open unit	Bianco altea Metallo argento	2	194	
	<b>TFB013UQ</b>	Comò THAI 2 cassetti e vano a giorno Dresser THAI with 2 drawers and open unit	Bianco altea Metallo argento	1	200	
	<b>BFB012QQ</b>	Letto REFLEX con rete contenitore 160x190, rete inclusa Bed with box REFLEX with 160x190 bedspring included	Bianco altea	1	449	
	<b>TFB025</b>	Specchiera WINDOW WINDOW mirror	-	1	66	

**COMPOSIZIONI A CATALOGO**  
CATALOGUE COMPOSITIONS

<b>VFB015</b>		<b>1.947 €</b>		<b>Codice</b>	<b>Descrizione</b>	<b>Finitura</b>	<b>QT.</b>	<b>€</b>
				Code	Description	Finish		
	<b>RFB022BT</b>	Armadio H245 2 ante scorrevoli L90 con specchio 2 L90 sliding doors wardrobe H245 with mirror door	Olmo natura Metallo oro	1	663			
	<b>TFB012TB</b>	Comodino THAI 1 cassetto e vano a giorno Night stand THAI with 1 drawer and open unit	Olmo natura Metallo oro	2	194			
	<b>TFB014TB</b>	Settimino THAI 4 cassetti e vano a giorno 4 drawers unit THAI with open unit	Olmo natura Metallo oro	1	210			
	<b>TFB013TB</b>	Comò THAI 2 cassetti e vano a giorno Dresser THAI with 2 drawers and open unit	Olmo natura Metallo oro	1	200			
	<b>BFB039WW</b>	Letto MISAM con rete contenitore 160x190, rete inclusa Bed with box MISAM with 160x190 bedspring included	Lira tortora	1	581			
	<b>TFB026</b>	Specchiera ROLLER L ROLLER L mirror	-	1	99			

<b>VFB013</b>		<b>2.074 €</b>		<b>Codice</b>	<b>Descrizione</b>	<b>Finitura</b>	<b>QT.</b>	<b>€</b>
				Code	Description	Finish		
	<b>RFB026RE</b>	Armadio H245 2 ante PROFILO scorrevoli L135 2 L135 PROFILO sliding doors wardrobe H245	Noce biondo Bianco lucido	1	990			
	<b>TFB001REM1</b>	Comodino CADY 2 cassetti Night stand CADY with 2 drawers	Noce biondo Bianco lucido	2	218			
	<b>TFB002REM1</b>	Comò CADY 3 cassetti Dresser CADY with 3 drawers	Noce biondo Bianco lucido	1	219			
	<b>BFB037VV</b>	Letto ATIK con rete contenitore 160x190, rete inclusa Bed with box ATIK with 160x190 bedspring included	Lira bianco	1	581			
	<b>TFB025</b>	Specchiera WINDOW WINDOW mirror	-	1	66			

<b>VFB014</b>		<b>1.652 €</b>		<b>Codice</b>	<b>Descrizione</b>	<b>Finitura</b>	<b>QT.</b>	<b>€</b>
				Code	Description	Finish		
	<b>RFB010DDM2</b>	Armadio H245 5 ante con 1 anta specchio 5 doors wardrobe H245 with 1 mirror door	Orzo	1	514			
	<b>TFB009DDM2</b>	Comodino LUX 2 cassetti Night stand LUX with 2 drawers	Orzo	2	174			
	<b>TFB010DDM2</b>	Comò LUX 3 cassetti Dresser LUX with 3 drawers	Orzo	1	175			
	<b>BFB042YY</b>	Letto DIONE BASIC con rete contenitore 160x190, rete inclusa Bed with box DIONE BASIC with 160x190 bedspring included	Cetra antracite	1	690			
	<b>TFB026</b>	Specchiera ROLLER L ROLLER L mirror	-	1	99			

<b>VFB009</b>		<b>1.607 €</b>		<b>Codice</b>	<b>Descrizione</b>	<b>Finitura</b>	<b>QT.</b>	<b>€</b>
				Code	Description	Finish		
	<b>RFB002QUM2</b>	Armadio H245 2 ante 2 doors wardrobe H245	Bianco altea Metallo argento	2	440			
	<b>AFB001Q</b>	Libreria H245 L35 Bookcase L35 H245	Bianco altea	1	218			
	<b>TFB015UQ</b>	Comodino DUO 2 cassetti Night stand DUO with 2 drawers	Bianco altea Metallo argento	2	236			
	<b>TFB017UQ</b>	Settimino DUO 5 cassetti 5 drawers unit DUO	Bianco altea Metallo argento	1	235			
	<b>BFB033QQ</b>	Letto VULCANO con rete contenitore 160x190, rete inclusa Bed with box VULCANO with 160x190 bedspring included	Bianco altea	1	478			

**COMPOSIZIONI A CATALOGO**  
CATALOGUE COMPOSITIONS

<b>VFB012</b>		<b>1.964 €</b>		<b>Codice</b>	<b>Descrizione</b>	<b>Finitura</b>	<b>QT.</b>	<b>€</b>
				Code	Description	Finish		
	<b>RFB001RRM2</b>	Armadio H245 1 anta 1 door wardrobe H245	Noce biondo	2	350			
	<b>AFB001R</b>	Libreria H245 L35 Bookcase L35 H245	Noce biondo	2	436			
	<b>RFB002RTM2</b>	Armadio H245 2 ante 2 doors wardrobe H245	Noce biondo Metallo oro	1	220			
	<b>TFB015TR</b>	Comodino DUO 2 cassetti Night stand DUO with 2 drawers	Noce biondo Metallo oro	2	236			
	<b>TFB016TR</b>	Comò DUO 3 cassetti Dresser DUO with 3 drawers	Noce biondo Metallo oro	1	225			
	<b>BFB003RT</b>	Letto SLIM con rete contenitore 160x190, rete inclusa Bed with box SLIM with 160x190 bedspring included	Noce biondo Metallo oro	1	431			
<b>TFB025</b>	Specchiera WINDOW WINDOW mirror	-	1	66				

<b>VFB001</b>		<b>1.533 €</b>		<b>Codice</b>	<b>Descrizione</b>	<b>Finitura</b>	<b>QT.</b>	<b>€</b>
				Code	Description	Finish		
	<b>RFB011RRM1</b>	Armadio H245 6 ante con 2 ante specchio 6 doors wardrobe H245 with 2 mirror doors	Noce biondo	1	597			
	<b>TFB006DD</b>	Comodino AUX 2 cassetti Night stand AUX with 2 drawers	Orzo	2	210			
	<b>TFB007DD</b>	Comò AUX 3 cassetti Dresser AUX with 3 drawers	Orzo	1	178			
	<b>TFB025</b>	Specchiera WINDOW WINDOW mirror	-	1	66			
	<b>BFB009RD</b>	Letto METIZ-GEMINI con rete contenitore 160x190, rete inclusa Bed with box METIZ-GEMINI with 160x190 bedspring included	Noce biondo Orzo	1	482			

<b>VFB011</b>		<b>1.931 €</b>		<b>Codice</b>	<b>Descrizione</b>	<b>Finitura</b>	<b>QT.</b>	<b>€</b>
				Code	Description	Finish		
	<b>RFB024QE</b>	Armadio H245 3 ante scorrevoli L90 con specchio centrale 3 L90 sliding doors wardrobe H245 with mirror door	Bianco altea Bianco lucido	1	999			
	<b>TFB006QQ</b>	Comodino AUX 2 cassetti Night stand AUX with 2 drawers	Bianco altea	2	210			
	<b>TFB007QQ</b>	Comò AUX 3 cassetti Dresser AUX with 3 drawers	Bianco altea	1	178			
	<b>BFB033QQ</b>	Letto VULCANO con rete contenitore 160x190, rete inclusa Bed with box VULCANO with 160x190 bedspring included	Bianco altea	1	478			
	<b>TFB025</b>	Specchiera WINDOW WINDOW mirror	-	1	66			

<b>VFB006</b>		<b>1.626 €</b>		<b>Codice</b>	<b>Descrizione</b>	<b>Finitura</b>	<b>QT.</b>	<b>€</b>
				Code	Description	Finish		
	<b>RFB025RU</b>	Armadio H245 2 ante PROFILO scorrevoli L120 2 L120 PROFILO sliding doors wardrobe H245	Noce biondo Metallo argento	1	850			
	<b>TFB015UR</b>	Comodino DUO 2 cassetti Night stand DUO with 2 drawers	Noce biondo Metallo argento	2	236			
	<b>TFB016UR</b>	Comò DUO 3 cassetti Dresser DUO with 3 drawers	Noce biondo Metallo argento	1	225			
	<b>BFB010RR</b>	Letto REFLEX per rete da 160x190, rete esclusa Standard bed REFLEX for 160x190 bedspring (excluded)	Noce biondo	1	249			
	<b>TFB025</b>	Specchiera WINDOW WINDOW mirror	-	1	66			

**COMPOSIZIONI A CATALOGO**  
CATALOGUE COMPOSITIONS

<b>VFB010</b>	<b>1.093 €</b>	<b>Codice</b> Code	<b>Descrizione</b> Description	<b>Finitura</b> Finish	<b>QT.</b>	<b>€</b>
	<b>RFB006QQM1</b>	Armadio H245 6 ante 6 doors wardrobe H245	Bianco altea	1	522	
	<b>TFB003QQM1</b>	Comodino SMALL 2 cassetti Night stand SMALL with 2 drawers	Bianco altea	2	174	
	<b>TFB004QQM1</b>	Comò SMALL 3 cassetti Dresser SMALL with 3 drawers	Bianco altea	1	181	
	<b>BFB043QQ</b>	Letto METIZ-GIGLIO per rete da 160x190, rete esclusa Standard bed METIZ-GIGLIO for 160x190 bedspring (excluded)	Bianco altea	1	150	
	<b>TFB025</b>	Specchiera WINDOW WINDOW mirror	-	1	66	

<b>VFB007</b>	<b>1.264 €</b>	<b>Codice</b> Code	<b>Descrizione</b> Description	<b>Finitura</b> Finish	<b>QT.</b>	<b>€</b>
	<b>RFB002RRM1</b>	Armadio H245 2 ante 2 doors wardrobe H245	Noce biondo	1	220	
	<b>AFB041RR</b>	Boiserie H245 L60 con portavaligia Boiserie H245 L60 with luggage rack	Noce biondo	1	267	
	<b>TFB012DR</b>	Comodino THAI 1 cassetto e vano a giorno Night stand THAI with 1 drawer and open unit	Noce biondo Orzo	2	194	
	<b>BFB044RD</b>	Letto METIZ-GIGLIO con rete fissa 160x190, rete inclusa Standard bed METIZ-GIGLIO with 160x190 fixed bedspring included	Noce biondo Orzo	1	275	
	<b>TFB019RR</b>	Scrivanina sinistra L150 con base frigo e fianco a L L150 left desk with fridge base and L-shaped side	Noce biondo	1	269	
<b>AFB054R</b>	Mensola L.60 per boiserie L.60 shelf for boiserie	Noce biondo	1	39		

<b>VFB004</b>	<b>1.102 €</b>	<b>Codice</b> Code	<b>Descrizione</b> Description	<b>Finitura</b> Finish	<b>QT.</b>	<b>€</b>
	<b>RFB011BBM2</b>	Armadio H245 6 ante con 2 ante specchio 6 doors wardrobe H245 with 2 mirror doors	Olmo natura	1	597	
	<b>TFB003BBM2</b>	Comodino SMALL 2 cassetti Night stand SMALL with 2 drawers	Olmo natura	2	174	
	<b>TFB004BBM2</b>	Comò SMALL 3 cassetti Dresser SMALL with 3 drawers	Olmo natura	1	181	
	<b>BFB043BB</b>	Letto METIZ-GIGLIO per rete da 160x190, rete esclusa Standard bed METIZ-GIGLIO for 160x190 bedspring (excluded)	Olmo natura	1	150	

<b>VFB008</b>	<b>1.595 €</b>	<b>Codice</b> Code	<b>Descrizione</b> Description	<b>Finitura</b> Finish	<b>QT.</b>	<b>€</b>
	<b>RFB003BUM1</b>	Armadio H245 3 ante 3 doors wardrobe H245	Olmo natura Metallo argento	1	342	
	<b>AFB042B</b>	Boiserie H245 L90 con portavaligia, con 2 appendiabiti colore titanio inclusi Boiserie H245 L90 with luggage rack, with 2 titanium coloured coat hangers	Olmo natura	1	335	
	<b>TFB003BUM1</b>	Comodino SMALL 2 cassetti Night stand SMALL with 2 drawers	Olmo natura Metallo argento	2	174	
	<b>BFB002BU</b>	Letto SLIM con rete fissa 160x190, rete inclusa Standard bed SLIM with 160x190 fixed bedspring included	Olmo natura Metallo argento	1	381	
	<b>AFB048B</b>	Libreria optional per letto SLIM Optional bookcase for SLIM bed	Olmo natura	1	49	
	<b>TFB019BU</b>	Scrivanina sinistra L150 con base frigo e fianco a L L150 left desk with fridge base and L-shaped side	Olmo natura Metallo argento	1	269	
<b>AFB055R</b>	Mensola L.90 per boiserie L.90 shelf for boiserie	Olmo natura	1	45		

**COMPOSIZIONI A CATALOGO**  
CATALOGUE COMPOSITIONS

<b>VFB017</b>	<b>1.827 €</b>	<b>Codice</b> Code	<b>Descrizione</b> Description	<b>Finitura</b> Finish	<b>QT.</b>	<b>€</b>
	<b>RFB029QEM2</b>	Ponte H245 con 2 vani da 90 Bridge unit H245 with 2 L90 units	Bianco altea Bianco lucido	1	967	
	<b>AFB003U</b>	Libreria ponte verticale Vertical bookcase for bridge unit	Metallo argento	2	202	
	<b>AFB004U</b>	Libreria ponte orizzontale Horizontal bookcase for bridge unit	Metallo argento	1	122	
	<b>TFB001EE</b>	Comò AUX 3 cassetti Dresser AUX with 3 drawers	Bianco lucido	1	221	
	<b>TFB025</b>	Specchiera WINDOW WINDOW mirror	-	1	66	
	<b>BFB010QQ</b>	Letto REFLEX per rete da 160x190, rete esclusa Standard bed REFLEX for 160x190 bedspring (excluded)	Bianco altea	1	249	

<b>VFB019</b>	<b>2.684 €</b>	<b>Codice</b> Code	<b>Descrizione</b> Description	<b>Finitura</b> Finish	<b>QT.</b>	<b>€</b>
	<b>RFB028RH</b>	Terminale destro H245 con anta specchio Left end unit H245 with mirror door	Noce biondo	1	259	
	<b>RFB002RUM1</b>	Armadio H245 2 ante 2 doors wardrobe H245	Noce biondo Metallo argento	1	220	
	<b>RFB013RUM1</b>	Cabina H245 Clothes closet unit H245	Noce biondo Metallo argento	1	427	
	<b>AFB001R</b>	Libreria H245 L35 Bookcase L35 H245	Noce biondo	1	218	
	<b>RFB018RUM1</b>	Ponte H245 con 2 vani da 45 Bridge unit H245 with 2 L45 units	Noce biondo Metallo argento	1	758	
	<b>AFB003U</b>	Libreria ponte verticale Vertical bookcase for bridge unit	Metallo argento	2	202	
	<b>AFB004U</b>	Libreria ponte orizzontale Horizontal bookcase for bridge unit	Metallo argento	1	122	
	<b>BFB033RR</b>	Letto VULCANO con rete contenitore 160x190, rete inclusa Bed with box VULCANO with 160x190 bedspring included	Noce biondo	1	478	

<b>VFB018</b>	<b>2.543 €</b>	<b>Codice</b> Code	<b>Descrizione</b> Description	<b>Finitura</b> Finish	<b>QT.</b>	<b>€</b>
	<b>RFB019BTM2</b>	Ponte H245 con un vano da 45 e uno da 90 Bridge unit H245 with L45 and L90 units	Olmo natura Metallo oro	1	834	
	<b>RFB014BH</b>	Angolo H245 con anta specchio Corner unit H245 with mirror door	Olmo natura	1	369	
	<b>RFB001BTM2</b>	Armadio H245 1 anta 1 door wardrobe H245	Olmo natura Metallo oro	1	175	
	<b>AFB001B</b>	Libreria H245 L35 Bookcase L35 H245	Olmo natura	1	218	
	<b>RFB016BTM2</b>	Terminale destro H245 Right end unit H245	Olmo natura Metallo oro	1	218	
	<b>BFB033BB</b>	Letto VULCANO con rete contenitore 160x190, rete inclusa Bed with box VULCANO with 160x190 bedspring included	Olmo natura	1	478	
	<b>AFB005T</b>	Mensola sottoponte Shelf for bridge unit	Metallo oro	1	49	
<b>AFB003T</b>	Libreria ponte verticale Vertical bookcase for bridge unit	Metallo oro	2	202		

## SCHEDA PRODOTTO

### PRODUCT SHEET

#### ELEMENTI DI STRUTTURA

##### Pannelli

- In particelle legnose classe E1, spessori 14 - 18 - 25mm, nobilitati con carta melaminico antigraffio, alta qualità, stampata in più finiture.

##### Bordi

- In materiale termoplastico, spessore 0,3 - 1 mm.

##### Pannelli Schienale

- In fibra legnosa classe E1, spessore 2,8 mm.

##### Cassetti

- Fondo in fibra legnosa, classe E1, spessore 2.8 - 3 mm.  
- Sponde in particelle legnose classe E1, spessori 12 mm, rivestite in PVC.  
- Guide in in metallo con ruote.

#### ELEMENTI FRONTALI

##### Pannelli

- Di particelle legnose, classe E1, spessore 18 - 25 mm, nobilitati con carta melaminico antigraffio, alta qualità, stampata in più finiture.

##### Bordi

- In materiale termoplastico, spessore 0,3 - 1 mm.

##### Specchi interni ed esterni

- Realizzati in vetro argentato sp.3mm.

##### Vernici

- In resine di poliestere, lucide e opache, applicate a velo ed essiccate a raggi UV.

##### Decorativi

- In fibra legnosa + spessori rivestita con carta finish oppure carta verniciata.

##### Ferramenta

- Maniglie in alluminio estruso e materiale termoplastico stampato.  
- Cerniere in metallo stampato con finitura nichelata.  
- Altra ferramenta in metallo stampato o in pressofusione di zama, rifinita con applicazione di vernici epossidiche ad alta resistenza.

#### METODI DI LAVORAZIONE

##### Bordatura

- Colle poliuretatiche / colle termo-fusibili.

##### · Materiali e/o sostanze che possono arrecare danno a cose, uomo o ambiente

- Nessuna.

##### Imballaggio

- L'imballaggio del prodotto deve essere smaltito secondo le normative vigenti nel comune in cui avviene il disimballo del prodotto.

#### AVVERTENZA DI SICUREZZA RELATIVE ALL'USO DEL PRODOTTO

##### Montaggio

- Il montaggio deve essere eseguito in base alle indicazioni delle istruzioni di montaggio.

##### Posizionamento

- Il ribaltamento del mobile può causare lesioni anche fatali pertanto il mobile deve quindi essere fissato permanentemente alla parete per prevenire il rischio. Gli accessori per eseguire il fissaggio non sono inclusi perché ogni parete richiede un accessorio di fissaggio specifico. Rivolgetevi a un rivenditore specializzato per identificare il sistema di fissaggio adatto per per fissare il mobile sulla parete da voi scelta.

##### Accessori interni

- Portacravatte e portapantaloni realizzati in MDF rivestito con carta stampata in più finiture.  
- Servetto estraibile in metallo estruso e materiali termoplastici.  
-Portascarpe in metallo con particolari in materiale termoplastico.  
- Tubi interni in metallo estruso.  
- Impianti per illuminazione interna acquistati precablati nel rispetto della normativa vigente.

##### Manutenzione e Smaltimento

- La pulizia di tutte le parti del mobile va eseguita, per non danneggiarne le finiture, utilizzando prodotti specifici, che non contengano acetone, ammoniaca e agenti solventi o abrasivi.  
Al termine del suo ciclo di utilizzo, il prodotto non deve essere disperso nell'ambiente, ma affidato all'azienda comunale di smaltimento rifiuti solidi urbani, per il trasporto in discarica o il possibile recupero.

#### STRUCTURAL ELEMENTS

##### Panels

- In class E1 wood particle boards, thickness 14 - 18 - 25mm, finished with high-grade scratch-resistant melamine printed in a selection of finishes.

##### Edgings

- In thermoplastic material, thickness 0.3 - 1 mm.

##### Back Panels

- In class E1 wood fibreboard, thickness 2,8mm.

##### Drawers

- Bottom in class E1 wood fibreboard, thickness 2.8 - 3 mm.  
- Sides in class E1 wood particle board, thickness 12 mm, finished with PVC.  
- Runners in metal with wheels.

#### FRONT ELEMENTS

##### Panels

- In class E1 wood particle boards, thickness 18 - 25mm, finished with high-grade scratch-resistant melamine printed in a selection of finishes.

##### Edgings

- In thermoplastic material, thickness 0.3 - 1 mm.

##### Internal and external mirrors

- In 3mm thick silver-backed glass.

##### Paints

- In gloss and matt polyurethane resin, applied in air curtain and UV-dried.

##### Decorative frames

- In wood fibreboard of varying thickness faced with wooden-effect or painted melamine.

##### Hardware

- Handles in extruded aluminium and moulded thermoplastic.  
- Hinges in press-formed metal with nickel colour finish.  
- Other hardware in press-formed metal or die-cast Zamak, finished with high-strength epoxy paints.

#### PRODUCTION METHODS

##### Edge-banding

- Polyurethane adhesives / Hot-melt adhesives.

##### MATERIALS AND/OR SUBSTANCES WHICH MAY BE HARMFUL TO PEOPLE, PROPERTY OR THE ENVIRONMENT

- None.

##### Packaging

- The product's packaging must be disposed of in accordance with the regulations in force in the location where the product is unpacked.

#### SAFETY WARNINGS CONCERNING USE OF THE PRODUCT

##### Assembly

- Assembly must be carried out in accordance with the instructions provided.

##### Positioning

- Overturning of furniture units may cause even fatal injury, so the unit must be permanently fixed to the wall to prevent this risk. Fixing accessories are not included because every wall requires a specific fixing accessory. Contact a specialist retailer for advice on the fixing system suitable for anchoring the unit to your chosen wall.

##### Internal accessories

- Tie and trouser racks in MDF board finished with melamine printed in a selection of finishes.  
- Pull-out hangers in extruded metal and thermoplastics.  
- Shoe rack in metal with thermoplastic components.  
- Hanger tubes in extruded metal.  
-Internal lighting systems purchased prewired in accordance with current legal requirements.

##### Care and Disposal

- To avoid damaging the finishes, all parts of the furniture unit must be cleaned using specific products which do not contain acetone, ammonia or solvents or abrasives.

At the end of its life-cycle, the product must not be dumped in the environment: contact the municipal urban solid waste disposal service for landfill disposal or recycling if possible.

## CONDIZIONI GENERALI DI VENDITA

### GENERAL TERMS OF SALE

#### 1. Decorrenza

Il presente listino decorre dal mese di Gennaio 2020.

#### 2. Caratteristiche dei Prodotti - Modifiche

2.1 Eventuali informazioni o dati sulle caratteristiche e/o specifiche tecniche dei Prodotti contenute in dépliant, listini, prezzi, cataloghi o documenti similari saranno vincolanti solo nella misura in cui tali dati siano stati espressamente richiamati dal contratto o conferma d'ordine.

2.2 Il Venditore si riserva di apportare ai Prodotti le modifiche che, senza alterare le caratteristiche essenziali dei Prodotti, dovessero risultare necessarie o opportune.

2.3 I colori e le finiture di tutti i materiali sono soltanto indicativi non essendo possibile assicurarne l'invariabilità nel tempo. L'esposizione diretta dei Prodotti alla luce solare, ad alta o bassa temperatura o umidità può alterare i colori. Il venditore, a tal riguardo, declina ogni responsabilità per eventuali inesattezze di stampa.

#### 3. Accettazione dell'Ordine

I preventivi e/o offerte del Venditore non costituiscono proposte contrattualmente vincolanti. Ogni ordine è assunto dal Venditore con riserva di accettazione e si intenderà confermato solo nel caso in cui il Venditore lo confermi per iscritto.

#### 4. Termini di Resa - Consegna

4.1 Fatto salvo quanto diversamente concordato per iscritto e di volta in volta tra il Venditore ed il Compratore, i Prodotti saranno consegnati in conformità al termine di resa Ex Works loaded Incoterms® 2010.

4.2 A prescindere dal termine di resa concordato tra il Venditore e l'Acquirente, il Venditore non sarà in alcun modo responsabile in caso di furto, perimento o di deterioramento dei Prodotti durante il trasporto a causa di atti o omissioni del trasportatore.

4.3 Nel caso in cui si verifichi un ritardo nella consegna imputabile al Venditore, a condizione che tale ritardo non sia superiore a 6 (sei) settimane intere ("Periodo di Grazia"), l'Acquirente non avrà alcun risarcimento del danno. Qualora il ritardo sia superiore al Periodo di Grazia, l'Acquirente avrà diritto al pagamento di una penale di importo pari al 5% (cinque per cento) del prezzo dei Prodotti che non sono stati consegnati entro il periodo suindicato, per ogni settimana intera di ritardo accumulata dopo la fine dello steso Periodo di Grazia, entro il limite massimo del 10%(dieci per cento) del prezzo di tali Prodotti.

4.4 Salvo il caso di dolo o colpa grave, il pagamento degli importi suindicati nel presente articolo esclude qualsiasi altro diritto al risarcimento del danno subito a causa di, o in connessione con, un ritardo nella consegna dei Prodotti.

#### 5. Garanzia - Reclami

5.1 Il Venditore garantisce all'Acquirente che i Prodotti saranno privi di difetti di fabbricazione e conformi all'ordine confermato. La presente garanzia avrà la durata di 24 (ventiquattro) mesi dal momento della consegna.

5.2 L'Acquirente dovrà esaminare i Prodotti nel più breve tempo possibile e, a pena di decadenza dalla presente garanzia, denunciare per iscritto al Venditore, per fax o per e-mail:

a. difformità relative alla tipologia e/o alla quantità dei Prodotti consegnati nonché i difetti o difformità palesi dei Prodotti entro e non oltre 8 (otto) giorni dalla consegna;

b. difetti o difformità occulti dei Prodotti entro e non oltre 8 (otto) giorni dalla scoperta e, comunque, entro il periodo di garanzia.

5.3 Nel caso in cui i Prodotti siano riconosciuti dal Venditore come effettivamente difettosi o difformi, l'Acquirente, a scelta del Venditore, avrà esclusivamente diritto:

a. alla riparazione o sostituzione gratuita dei Prodotti difettosi o difformi, nel qual caso il Venditore diventerà proprietario dei Prodotti che sono stati sostituiti;

b. oppure all'esonzione parziale o totale dal pagamento del prezzo, a seconda della gravità dei difetti o delle difformità, con emissione di nota di credito.

5.4 Non si accettano resi di prodotti se non espressamente autorizzati dal Venditore. I resi, anche se accettati, verranno accreditati al prezzo addebitato in fattura al momento dell'acquisto. Il Venditore si ritiene autorizzato a rifiutare il reso se la merce non sarà messa a disposizione per il ritiro entro il termine massimo di 30 (trenta) giorni dalla data di consegna. Il reso dovrà essere accompagnato da un documento di trasporto con relativo riferimento all'ordine.

5.5 E' inteso che eventuali reclami o contestazioni non danno diritto

all'Acquirente di sospendere o comunque ritardare i pagamenti dei Prodotti oggetto di contestazione, né, tanto meno, di altre forniture.

#### 6. Prezzi - Pagamento

6.1 I Prodotti verranno forniti ai prezzi riportati nel listino prezzi del Venditore in vigore al momento dell'ordine.

6.2 I prezzi riportati nel listino prezzi del Venditore si intendono in Euro al netto di IVA e per consegne secondo il termine di resa Ex Works Incoterms® 2010. Pertanto, nel caso in cui sia convenuto un diverso termine di resa, i prezzi indicati in fattura verranno modificati di conseguenza.

6.3 Fatto salvo quanto diversamente concordato per iscritto e di volta in volta tra il Venditore e l'Acquirente, il pagamento dei Prodotti acquistati dall'Acquirente dovrà essere effettuato mediante bonifico bancario entro 30(trenta )giorni prima della consegna.

#### 7. Imballaggio

7.1 I Prodotti saranno imballati ed approntati per la spedizione secondo i sistemi di protezione generalmente adottati dal Venditore per le modalità di trasporto convenute.

7.2 Qualora l'Acquirente ritenga necessario l'impiego di imballaggi speciali o di protezioni aggiuntive, dovrà farne espressa richiesta al Venditore, fermo restando che, in tal caso, saranno a carico dell'Acquirente tutti i relativi costi.

#### 8. Riserva di Proprietà

E' convenuto che i Prodotti consegnati restano di proprietà del Venditore fino a quando non sia pervenuto a quest'ultimo il completo pagamento.

#### 9. Diritti di Proprietà Industriale

L'Acquirente si impegna a non usare e a non registrare né far registrare qualsiasi marchio, nome o segno distintivo di del Venditore o qualsiasi marchio, nome o segno distintivo confondibile con quelli del Venditore.

#### 10. Forza maggiore

10.1 Ciascuna parte potrà sospendere l'esecuzione dei suoi obblighi contrattuali quando tale esecuzione sia resa impossibile o irragionevolmente onerosa da un impedimento imprevedibile indipendente dalla sua volontà quale ad es. sciopero, boicottaggio, serrata, incendio, guerra (dichiarata o non), guerra civile, sommosse e rivoluzioni, requisizioni, embargo, interruzioni di energia, ritardi, nella consegna di componenti o materie prime.

10.2 La parte che desidera avvalersi della presente clausola dovrà comunicare immediatamente per iscritto con lettera raccomandata con ricevuta di ritorno, all'altra parte il verificarsi e la cessazione delle circostanze di forza maggiore.

10.3 Qualora la sospensione dovuta a forza maggiore duri più di 3 (tre) mesi, ciascuna parte ha diritto di risolvere il contratto previo un preavviso di 10 (dieci) giorni, da comunicarsi alla controparte per iscritto con lettera raccomandata con ricevuta di ritorno.

#### 11. Legge Applicabile - Foro Competente

11.1 Il presente contratto sarà regolato dalla legge italiana.

Tutti i contratti di vendita che le Parti stipuleranno in base al presente Contratto saranno regolati dalla Convenzione di Vienna del 1980 sulla vendita internazionale di merci e, nelle materie non coperte da tale Convenzione, dalla legge italiana.

11.2 Per qualsiasi controversia derivante dal contratto o collegata allo stesso sarà esclusivamente competente il Foro della sede del Venditore. Tuttavia, in deroga a quanto stabilito sopra, il Venditore ha comunque la facoltà di portare la controversia davanti al giudice compente presso la sede dell'Acquirente.

#### 1. Effective Date

The present catalog accrues from the month of January 2020.

#### 2. Characteristics of Products - Modifications

2.1 Any information or data relating to technical features and/or specifications oh the Products contained in dépliant, price, lists, catalogues and similar documents shall be binding only to extent they are expressly referred to in the Agreement.

2.2 The Seller may make any change to the Products which without altering their essential features, appear to be necessary or suitable.

2.3 The colors and the finishing are only indicative since it is technically impossible to guarantee them over time. Direct exposure of the Products to sunlight, high and low temperatures or humidity can alter the colors. The Seller, in this respect, is not responsible for the accuracy of the press.

#### 3. Acceptance of the Order

The Seller's estimates and/or quotations are not contractually binding proposals. Each order is assumed by the Seller with reserve of acceptance and will be considered confirmed only if the Seller confirms this in writing.

#### 4. Delivery term - Time of Delivery

4.1 Unless otherwise agreed upon in writing and from time to time between The Seller and the Buyer, The Products shall be delivered according to the delivery term Ex Works loaded Incoterms® 2010.

4.2 Irrespectively of the delivery term agreed upon between the Sellers and the Buyer, the Seller shall not be liable in case of theft, loss or deterioration of the Products during transport as a consequence of acts or omissions of the carrier.

4.3 If a delay in delivery of the Products occurs, for which the Seller is responsible, on condition that such delay does not exceed 6 (six) full weeks ("Grace Period"), the Buyer will not be entitled to any compensation or reimbursement for damages whatsoever. In case such delay exceeds the Grace Period, the Buyer will be entitled to be paid liquidated damages equaling 5% (five percent) of the price of such Products which have not been delivered within the Grace Period, for each full week of delay after the end of the Grace Period, up the maximum amount equaling 10%(ten percent) of the price of such Products.

4.4 Except in case of fraud or gross negligence, the payment of the amounts indicated in this article excludes any further compensation for damages arising out of or in connection with any delay in delivery of the Products.

#### 5. Warranty - Claims

5.1 The Seller warrants to the Buyer that the Products will be free from manufacturing and material defects and that they will conform to the confirmed order. The warranty period is 24( twenty four) months from the moment of delivery.

5.2 The Buyer shall inspect the Products as soon as possible and shall notify the Seller of possible defects or non-conformities in writing, by fax or email, within and no later than the following terms; failing to do so will result in the lapse of the warranty and in warranty rights being time-barred:

a. differences in type or quantity with respect to type or quantity agreed as well as other patent defects or non-conformities 8 (eight) days from the delivery of the Products at the premises of the Buyer;

b. hidden defects or non-conformities of the Products 8 (eight) days from the discovery of the same and, for avoidance of doubt, within the warranty period above.

5.3 In case the Products are ascertained by the Seller as actually defective or non-conforming the Buyer will be entitled only to obtain at the Seller's option:

a. replacement of the defective or non-conforming Products at not costs to the Buyer, in which case the Seller shall become owner of the Products that have been replaced;

b. or partial or full exemption from payment of their price, depending on the seriousness of the defects or of the non-conformities. For this purpose, the Seller shall issue a credit note.

5.4 We do not accept returns of products unless expressly authorized by the Seller. The returns, even if accepted, will be credited to the price invoiced at the time of purchase. The Seller is

deemed authorized to refuse the return if the Products will not be made available for withdrawal within a maximum period of 30 (thirty) days from the date of delivery. The return must be accompanied by a movement document, with its reference to the order.

5.5 It is agreed that any complaints or objections do not entitle the Buyer to suspend or to delay payment of the Products as well as payment of any other supplies.

#### 6. Prices - Payment

6.1 The Products shall be supplied according to the price list of the Seller in force when the order is placed.

6.2 The prices in the price list of the Seller are in Euro, net of VAT and for delivery according to the delivery term Ex Works Incoterms® 2010. Therefore, should a different delivery term be agreed upon between the Seller and the Buyer, the invoiced prices shall be modified accordingly.

6.3 Except as otherwise from time to time agreed upon in writing between the Seller and the Buyer, any payment of the Products purchased by the Buyer shall be made by bank transfer within 30 (thirty) days before delivery.

#### 7. Packaging

7.1 The Products will be packaged and readied to ship in compliance with the standard protection methods generally adopted by the Seller for the agreed mode of transport.

7.2 The Buyer shall expressly request to the Seller any special packaging or supplementary protection it deems necessary; and in such event the Buyer will bear all related costs thereof.

#### 8. Retention of Title

It is agreed that the Products delivered remain the Seller's property until complete payment is received by the Buyer.

#### 9. Industrial Property Rights

The Buyer agrees not to use and not to record or to register any trademark, name or mark of the Seller or any brand, name or distinguishing mark confusingly similar to those of the Seller.

#### 10. Force Majeure

10.1 Either party shall have the right to suspend performance of his contractual obligations when such performance becomes impossible or unduly burdensome because of unforeseeable events beyond his control, such as strikes, boycotts, lock-outs, fires, war (either declared or not), civil war, riots, revolutions, requisitions, embargo, energy black-outs, delay in delivery of components or raw materials.

10.2 The party wishing to make use of the present clause must promptly communicate in writing to the other party the occurrence and the end of such force majeure circumstances.

10.3 Should the suspension due to force majeure last more than 3 (three) months, either party shall have the right to terminate the agreement by a 10 (ten) days' written by registered letter with return receipt.

#### 11. Applicable law - Jurisdiction

11.1 This agreement shall be governed by Italian laws.

All sales agreement that the parties shall execute pursuant to this agreement shall be governed by the United Nations Convention on Contracts for the International Sale of Goods –Vienna Convention of 1980 and, with respect to matters not covered by such Convention, by Italian laws.

11.2 The competent law courts of the place where the Seller has his registered office shall have exclusive jurisdiction in any action arising out of or in connection with this agreement. However, as an exception to the principle here above, the Seller is in any case entitled to bring his action before the competent court of the place where the Buyer has his registered office.

## CERTIFICAZIONI DEL PRODOTTO PRODUCT CERTIFICATIONS

IMAB GROUP aderisce a percorsi indirizzati alla qualità dei prodotti e alla tutela dell'ambiente. L'azienda da sempre sviluppa l'intero ciclo di produzione in Italia per garantire il 100% del risultato in originalità, design e valore.

IMAB GROUP implements strategies intended to ensure product quality and environmental protection. It has always carried out the entire production cycle in Italy to guarantee the very best results in terms of originality, design and value.



### ISO 9001:2015 - Sistema di Gestione Qualità

ISO 9001:2015 - Quality Management System

Standard internazionale che certifica che l'azienda IMAB Group gestisce tutti i propri processi interni (dal commerciale agli acquisti, dalla produzione alla spedizione) con lo scopo di rispondere in modo coerente ed esaustivo alle aspettative del cliente.

An international standard which certifies that IMAB Group manages all its internal processes (from sales to purchasing and from production to shipment) with the aim of providing a consistent, exhaustive response to the customer's expectations.



### ISO 14001:2015 - Sistema di Gestione Ambientale

ISO 14001:2015 - Environmental Management System

Standard internazionale che certifica che l'azienda IMAB Group è in grado di supervisionare e tenere sotto controllo tutti i propri processi interni che possono avere un impatto di tipo ambientale.

An international standard which certifies that IMAB Group is capable of supervising and monitoring all its internal processes which may have an environmental impact.



### OHSAS 18001:2007 - Occupational Health and Safety Assessment Series

OHSAS 18001:2007 - Occupational Health and Safety Assessment Series

Standard internazionale che attesta che l'azienda IMAB Group gestisce i propri processi interni garantendo la sicurezza la salute dei propri collaboratori nel rispetto delle norme cogenti.

An international standard which certifies that IMAB Group manages its internal processes with guarantees for the health and safety of its employees in compliance with the relevant regulatory requirements.



## CONFIGURATORE GRAFICO GRAPHIC PROGRAM

Il configuratore grafico di prodotto permette la progettazione grafica 3D di arredamenti di qualsiasi complessità: dalla posa del singolo elemento d'arredo alla composizione di ambientazioni complete. E' un applicativo particolarmente semplice da utilizzare e, grazie agli aiuti che fornisce durante la posa degli elementi, consente, anche ad operatori con pochissima esperienza, di realizzare proposte d'arredo con la massima precisione ed esattezza.

The graphic program allows all kinds of furniture 3D graphic design, from laying a single item to create a whole composition. It's very simple to use: thanks to the advices it gives during the design, it helps all graphic designers, even the less expert, to realize furnishing proposals with the maximum precision.

## Metron

applicativo per arredi Imab

E' uno strumento di VENDITA estremamente efficace e che, vista la sempre crescente complessità e maggiore richiesta di prodotti fortemente personalizzati, non solo nelle fasce alte del mercato ma anche per quelle più economiche, diviene, di fatto, indispensabile! Anche l'invio del preventivo confermato verso Imab Group S.p.A. è estremamente semplice e riduce enormemente il rischio di incomprensioni e conseguenti errori rispetto al classico invio via mail/fax.

It's a very efficient SALES tool and due to the constant increase of products' complexity and customization in each market segment... it's becoming essential! The sending of the order to Imab Group S.p.A. once confirmed is very simple too and reduce misunderstanding and mistakes compared to the classical method by mail/fax.

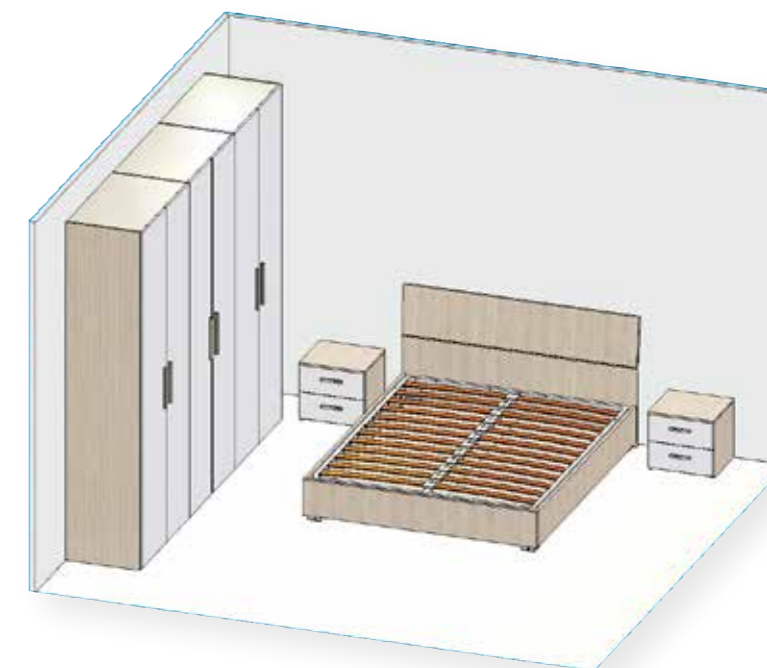

### Informazioni ed Assistenza

Information and Customer Service

Per sfruttare al meglio le potenzialità e facilitare l'utilizzo del software in fase di progettazione, nel sito web dedicato sono presenti delle guide che spiegano passo per passo le azioni che possono sembrare più complesse, in modo tale che diventino semplici ed automatiche. L'ufficio configuratore è disponibile per qualsiasi problema dal lunedì al venerdì dalle 8:30 alle 12:00 e dalle 14:00 alle 18:00.

In order to take full advantage of the potential and simplify the usage of the software during the project phase, in the dedicated web site are available some guides which explain step by step the more complicated actions in order to make them easier.

Imab Metron department is available for any problem from Monday to Friday from 8:30 to 12:00 and from 14:00 to 18:00.

-  +39 0722 335675
-  [configuratore@imab.com](mailto:configuratore@imab.com)
-  [configuratore.imab.com](http://configuratore.imab.com)
-  [configuratore imab](#)

Imab è presente anche su  
Imab is also available on







Il Gruppo Imab nasce nel 1968 dalla passione e dalla tenacia dell'imprenditore Antonio Bruscoli. Nel tempo abbiamo sviluppato e consolidato una mission aziendale unica e ambiziosa: creare uno stile di arredamento che contribuisca al benessere delle persone grazie alla combinazione di Ricerca, Tecnologia, Design Italiano e Capacità Artigianali. La nostra sede si trova a Fermignano, poco distante da Urbino. Proprio qui, nel cuore delle Marche, realizziamo la nostra produzione, ispirandoci a questa terra rigogliosa ricca di storia e tradizione.

The Imab Group was founded in 1968, thanks to the passion and determination of entrepreneur Antonio Bruscoli. Over time, it has developed and consolidated a unique corporate mission: the creation of a style of furniture capable of increasing people's well-being, through a combination of Research, Technology, Italian Design and Skilled Craftsmanship. We are based at Fermignano, not far from Urbino. It is here, in the heart of Italy's Marches region, that we produce our furniture, inspired by this fertile land, rich in history and tradition.

Le Groupe Imab est né en 1968 sous l'impulsion de l'entrepreneur Antonio Bruscoli. Au fil du temps, nous avons développé et consolidé une mission d'entreprise unique et ambitieuse : créer un style de mobilier qui contribue au bien-être des personnes grâce à une combinaison de Recherche, Technologie, Design Italien et Savoir-Faire Artisanal. Notre siège social est situé à Fermignano, près de Urbino. C'est ici, au cœur de la région Marches, que nous fabriquons nos produits, en nous inspirant de cette terre riche, chargée d'histoire et de tradition.



#### **Imab compie 50 anni.**

Da oltre 50 Anni copriamo il mercato mondiale, con una produzione 100% made in Italy.

#### **Imab turns 50.**

We have been covering the world market, with 100% Italian-made products, for more than 50 years.

#### **Imab fête ses 50 ans.**

Depuis plus de 50 ans, nous couvrons le marché mondial, avec des produits 100 % made in Italy.



#### **Abbiamo un cuore italiano.**

Il ciclo produttivo dei nostri mobili è totalmente integrato, a partire dalla materia prima di provenienza unicamente italiana, fino al prodotto finito.

#### **We have an Italian heart.**

The production cycle for our furniture is totally integrated, starting from the raw materials, all of strictly Italian origin, right through to the finished product.

#### **Nous avons à cœur de produire italien.**

Le cycle de production de nos meubles est entièrement intégré, de la matière première d'origine exclusivement italienne au produit fini.



#### **Una casa alla moda.**

La nostra mission è di creare un arredo per tutta la casa. Un total living accessibile e in linea con i gusti di tutti.

#### **A fashionable home.**

Our mission is to create furniture for the entire home. A total living-space concept, accessible and in line with everyone's taste.

#### **Une maison à la mode.**

Notre mission est de créer un mobilier pour toute la maison. Un total living abordable et conforme aux goûts de chacun.



#### **Una storia di qualità.**

Da sempre il Gruppo Imab aderisce a percorsi indirizzati alla qualità dei prodotti e alla tutela dell'ambiente.

#### **A history of quality.**

The Imab Group has always implemented strategies intended to ensure product quality and environmental protection.

#### **Une histoire de qualité.**

Le Groupe Imab s'est toujours engagé dans une politique de qualité des produits et de protection de l'environnement.



#### **Siamo più di mille!**

600 dipendenti e un indotto che conta oltre 1000 persone: una realtà innovativa e consolidata nel mercato mondiale.

#### **More than a thousand of us!**

600 employees and a supply chain of more than 1000 people: a major, innovative, consolidated player on the world market.

#### **Nous sommes plus d'un millier !**

600 employés et des retombées sur plus de 1000 personnes font de notre Groupe un acteur novateur et bien établi sur le marché mondial.



#### **Grandi numeri per un grande progetto.**

400.000m<sup>2</sup> di pannello lavorato in un mese. 130.000m<sup>2</sup> di superficie coperta. 140 camion distribuiscono nel mondo 90.000 colli di prodotto.

#### **Big numbers for a big project.**

400,000m<sup>2</sup> of boards processed. 130,000m<sup>2</sup> of buildings. 140 trucks distribute about 90,000 product items worldwide.

#### **De grands chiffres pour un grand projet.**

400.000m<sup>2</sup> de panneaux travaillés en un mois. 130.000m<sup>2</sup> de surface couverte. 140 camions distribuent 90.000 colis de produits dans le monde entier.



#### **Imab Group per la sostenibilità.**

Risparmio energetico e processi produttivi ad elevato livello qualitativo permettono una produzione con prezzi sempre più economici e convenienti mantenendo inalterati i livelli di qualità ed efficienza.

#### **Imab Group for sustainability.**

Energy saving and production processes with high quality level enable it to produce with more and more competitive, affordable prices, with exactly the same quality and efficiency levels.

#### **Imab Group pour le développement durable.**

Les économies d'énergie et les procédés de production de haute qualité permettent une production à des prix de plus en plus avantageux tout en maintenant les mêmes niveaux de qualité et d'efficacité.



## IMAB PER LA SOSTENIBILITÀ

Da sempre sosteniamo l'ambiente con progetti eco-friendly focalizzandoci prevalentemente sulla qualità dei nostri prodotti.

**Altissimi livelli di efficienza sono possibili grazie a un risparmio energetico nei processi produttivi.**

Crediamo che il sole e le energie rinnovabili possano contribuire al futuro della nostra azienda; per questo abbiamo installato diversi impianti fotovoltaici presso le nostre strutture, in modo che lo standard produttivo della nostra azienda sia perfettamente in linea ai modelli energetici internazionali.

## IMAB FOR SUSTAINABILITY

We have always supported the environment with eco-friendly projects, focusing mainly on our products' quality.

**Extremely high efficiency levels are possible thanks to energy saving in production processes.**

We believe that the sun and renewable energy sources can contribute to our company's future; this is why we have installed several photovoltaic plants at our locations, so that our company's production standard is perfectly in line with international energy models.

## IMAB POUR LE DEVELOPPEMENT DURABLE

Nous avons toujours soutenu l'environnement avec des projets respectueux de l'environnement, axés principalement sur la qualité de nos produits.

**Les économies d'énergie réalisées dans les procédés de production permettent d'atteindre des niveaux d'efficacité optimaux.**

Nous pensons que le soleil et les énergies renouvelables peuvent contribuer à l'avenir de notre entreprise ; c'est pourquoi nous avons installé plusieurs systèmes photovoltaïques dans nos installations, de sorte que le niveau de production de notre entreprise est parfaitement conforme aux modèles énergétiques internationaux.

## ENERGIE ALTERNATIVE, PER UNA PRODUZIONE RESPONSABILE. ALTERNATIVE ENERGIES, FOR RESPONSIBLE PRODUCTION. DES ENERGIES ALTERNATIVES POUR UNE PRODUCTION RESPONSABLE.



Crediamo che un certificato di qualità non sia solo un riconoscimento, ma una vera responsabilità verso l'ambiente, che con forza portiamo avanti valorizzando e qualificando le strutture produttive in un'ottica carbon neutral, a bassa emissione di Co2. Il nostro impegno è costantemente focalizzato sul territorio e sulla sostenibilità, al fine di poter immettere nel mercato un prodotto che sia responsabile ed ecologico al 100%.

We believe that a quality certification is not just an award but a real responsibility to the environment, which we pursue with determination, upgrading and updating our production plants with a carbon neutral approach, with low Co2 emissions. We are constantly committed to our local community and sustainability, to allow us to offer the market a 100% responsible, environment-friendly product.

Pour nous, un certificat de qualité n'est pas seulement une reconnaissance, c'est une véritable responsabilité envers l'environnement, que nous assumons avec détermination en améliorant et en qualifiant les installations de production dans une perspective de carbone neutre, avec de faibles émissions de CO2. Notre engagement est constamment focalisé sur le territoire et sur la durabilité, afin de pouvoir mettre sur le marché un produit responsable et 100 % écologique.



La promessa che facciamo a tutti i nostri clienti è fornire prestazioni eccellenti senza rinunciare all'integrità ambientale, sviluppando l'intero ciclo produttivo in Italia per garantire il 100% del risultato in originalità, design e valore. Il forte orientamento all'innovazione è il motore portante della collaborazione con il Gruppo Loccioni, integratore di tecnologie riconosciuto a livello mondiale e leader nell'efficienza energetica di prodotti, processi e building.

We promise all our customers excellent performance without sacrificing environmental integrity, carrying out the entire production cycle in Italy to guarantee the very best results in terms of originality, design and value. Our strong orientation towards innovation is the driving force behind our partnership with the Loccioni Group, world famous technology integrator and leader in the energy efficiency upgrading of products, processes and buildings.

La promesse que nous faisons à tous nos clients : fournir d'excellentes performances dans le respect de l'environnement, en développant tout le cycle de production en Italie pour assurer 100 % du résultat en originalité, design et valeur. La forte orientation vers l'innovation est le moteur de la collaboration avec le Groupe Loccioni, intégrateur technologique de renommée mondiale et leader dans le domaine de l'efficacité énergétique des produits, procédés et bâtiments.



Presso la sede principale di Imab Group è stato installato un Leaf Meter: il misuratore di sostenibilità che comunica in tempo reale i dati relativi alle performance energetiche e all'impatto ambientale degli edifici interessati.

A Leaf Meter, the sustainability meter that reports the energy performance and environmental impact data of the relevant buildings in real time, has been installed at the Imab Group headquarters.

Un Leaf Meter a été installé au siège du Groupe Imab : le compteur de durabilité qui fournit des données en temps réel sur la performance énergétique et l'impact environnemental des bâtiments concernés.

© 2020 IMAB GROUP

All rights reserved.  
È vietata la riproduzione  
anche parziale del  
seguinte catalogo senza  
autorizzazione scritta  
da parte dell'Azienda.

L'Azienda si riserva il  
diritto, in ogni momento  
e senza preavviso, di  
apportare modifiche alle  
specifiche dei Prodotti  
atte a migliorarne  
l'utilizzo. Le fotografie  
e le descrizioni  
presenti sui nostri siti  
internet o sul nostro  
catalogo non hanno  
valore contrattuale.  
Ci riserviamo di  
modificare il prodotto  
anche senza preavviso  
per migliorarne il  
funzionamento.

Tutti i diritti di quanto  
contenuto nel presente  
file appartengono a  
Imab Group S.p.A. in via  
esclusiva. È vietata la  
copia, la pubblicazione,  
la distribuzione o la  
riproduzione (anche  
parziale), se non  
autorizzata per iscritto.

**Design**

Gino Brini

**AD**

Eikon

**Fotolito**

Mic Studio

**Stampa**

Antezza Tipografi

Codice: Z2190800

Codice listino prezzi: 00

Collezione: facile

Testatina: GFAC2 - PFAC2

Uscita pubblicazione:  
01/2020





**Imab Group S.p.A.**  
Via L. Falasconi, 92  
61033 Fermignano (PU) - ITALY  
tel. +39 0722 335 701  
[www.imab.com](http://www.imab.com)